

Technical data

Shelf

design Falmecc Lab

Filtering version

Installation / Dimension

Wall
Sistema modulare componibile
Hood module 120 cm
Shelf modules 60, 90 cm

Features

Satin Black matt aluminium profiles; smoked glass, matt black painted steel hood body
o personalizzabile dal cliente;
veletta estraibile vetro fumé;
portatablet incluso

Technology

Multi-air

Control

Touch control
3 speed + Boost

Lighting

Dynamic Led Light

Motor

Brushless 500 m³/h

Filtration

Carbon.Zeo

Suction version

Installation / Dimension

Wall
Sistema modulare componibile
Hood module 120 cm
Shelf modules 60, 90 cm

Features

Satin Black matt aluminium profiles; smoked glass, matt black painted steel hood body
o personalizzabile dal cliente;
veletta estraibile vetro fumé;
portatablet incluso

Technology

No-Drop

Control

Touch control
3 speed + Boost

Lighting

Dynamic Led Light

Motor

To match
(vedi tabella Motori disponibili)



EAN Code	Code	Description
8034122362793	CKMN20.E0P2#ZZZN451F	Hood module Shelf 120 cm (filtering), frontale in alluminio nero satinato
8034122365299	CKMN20.E1P2#ZZZN400F	Hood module* Shelf 120 cm (suction), frontale in alluminio nero satinato
8034122365091	CKMN20.E2P2#ZZZN451F	Hood module Shelf 120 cm (filtering), frontale personalizzabile
8034122365305	CKMN20.E3P2#ZZZN400F	Hood module* Shelf 120 cm (suction), frontale personalizzabile
8034122713595	KACL.451#NF	Shelf module 60 cm black, frontale in alluminio nero satinato
8034122713601	KACL.452#NF	Shelf module 90 cm black, frontale in alluminio nero satinato
8034122713649	KACL.456#NF	Shelf module 60 cm black, frontale personalizzabile
8034122713656	KACL.457#NF	Shelf module 90 cm black, frontale personalizzabile

* Unità motore da ordinare separatamente

Available motors

8034122709833	KACL.798#41F	Motor 950 m ³ /h
8034122710211	KACL.770#41F	Motor brushless 1100 m ³ /h
8034122707433	KACL.786#41F	Aspiratore esterno 1000 m ³ /h

Accessories

8034122713663	KACL.458#3F	Vasca piante in acciaio per modulo mensola 90 cm
8034122713670	KACL.459#3F	Vasca piante in acciaio per modulo mensola 60 cm
8034122713533	KACL.966	Filtro Carbon.Zeo rigenerabile (ricambio)

Shelf filtering version

Hood module 120 cm

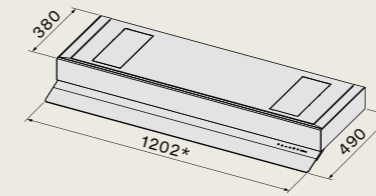

Vista laterale con pannello frontale in alluminio

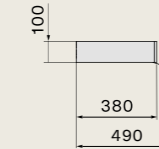

Vista laterale senza pannello frontale (versione personalizzabile)

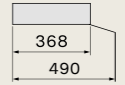

* quota comprensiva di tamponi laterali (1 mm + 1 mm)

Shelf suction version

Hood module 120 cm

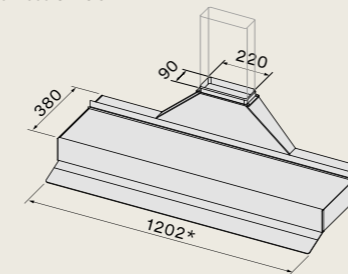

Vista laterale con pannello frontale in alluminio

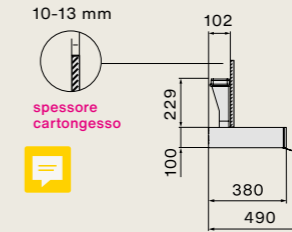

Vista laterale senza pannello frontale (versione personalizzabile)

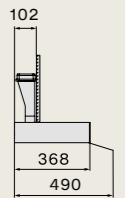

* quota comprensiva di tamponi laterali (1 mm + 1 mm)

Shelves

Module 90 cm

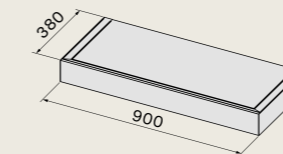

Module 60 cm

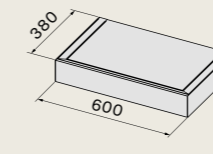

Configuration example

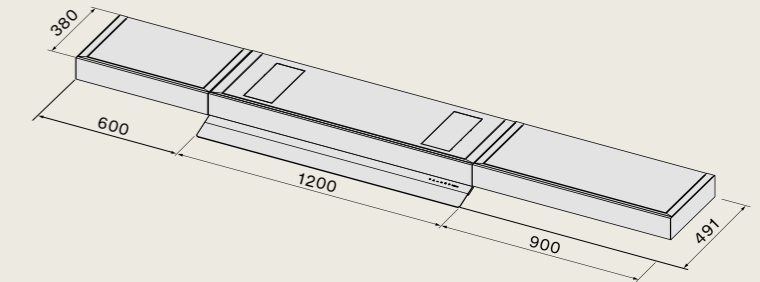

Accessories

Vasca piante per mensola 90 cm

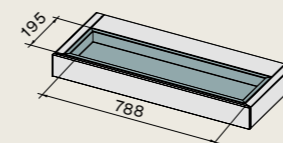

Vasca piante per mensola 60 cm

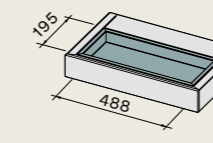

Porta tablet (incluso nel modulo cappa)

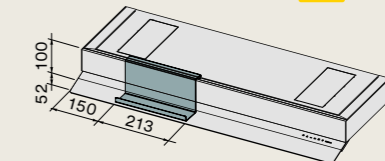

profondità vasca piante 50 cm

Monolith

design Falmecc Lab, Studio Ferriani

Installation / Dimension

Worktop
Sistema modulare componibile
 Hood module 90 cm
 Container modules 30, 60, 90 cm

Features

Struttura in alluminio nero opaco,
 pannello anteriore e posteriore
 in vetro satinato nero opaco

Control

Touch control
 3 speed + Boost
 Remote control (optional)
 Dialogue system*

Lighting

Ambient light (3000 K)

Motor

Brushless 800 m³/h

Filtration

Carbon.Zeo (optional)

Energy Class

A++

*Connectivity: hood and induction hob.
 Through the new Dialogue System, it is possible
 to control the various functions of the hood directly
 from the Falmecc induction hob.

EAN Code	Code	Description
8034122364698	CMOW90.00P8#ZZZN490F	Hood module
8034122713632	KACL.455#NF	Container module 90 cm
8034122713625	KACL.454#NF	Container module 60 cm
8034122713618	KACL.453#NF	Container module 30 cm
8034122713694	KACL.1018#NF	Modulo vasca aperta per piante 30 cm

Accessories

8034122713434	KACL.1006	Carbon.Zeo Filter (optional)
8034122713540	KACL.1010	Cutting board 293x128 mm / natural beech wood
8034122713557	KACL.1011	Cutlery tray (1 compartment) 291x128x54 mm / natural beech wood
8034122713564	KACL.1012	Cutlery tray (2 compartment) 291x128x54 mm / natural beech wood
8034122713571	KACL.1013	Cutlery tray (4 compartment) 446x128x54 mm / natural beech wood
8034122713588	KACL.1014	Knife rack 446x128x54 mm / natural beech wood
8034122713519	KACL.1015#H4F	Accessory sockets / usb + electrical
8034122713755	KACL.1021	Spices tray 291x128x54 mm / natural beech wood
8034122708317	105080053	Remote control

Monolith

Hood module 90 cm

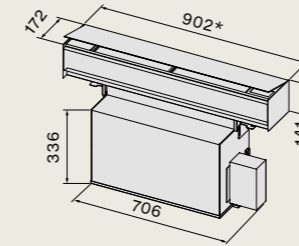

* quota comprensiva di tamponi laterali
 (2 mm + 2 mm)

Installation example*

Wall installation
 vista laterale con motore in posizione anteriore

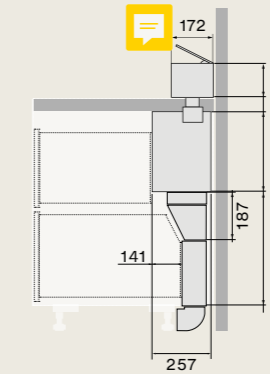

Cut-out on top (wall installation)

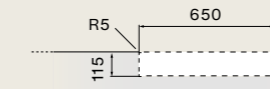

Island installation
 vista laterale con motore in posizione posteriore

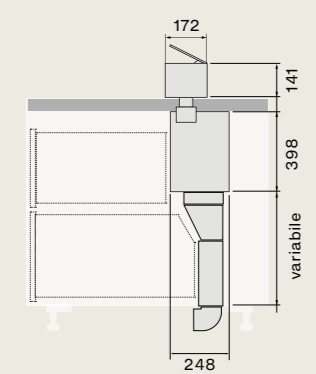

Cut-out on top (island installation)

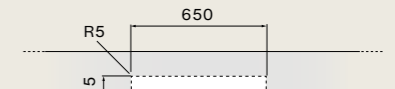

* sia l'installazione a parete che quella
 a isola permettono l'installazione del
 motore sia in posizione anteriore che in
 quella posteriore.

Container modules

Container module 90 cm

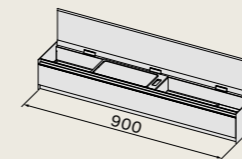

Container module 60 cm

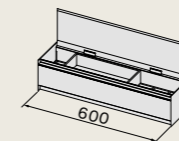

Container module 30 cm

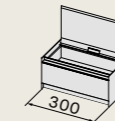

Modulo vasca aperta
 per piante 30 cm

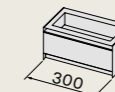

Esempio configurazione moduli accessori

Hood module 90 cm + container module 90 cm

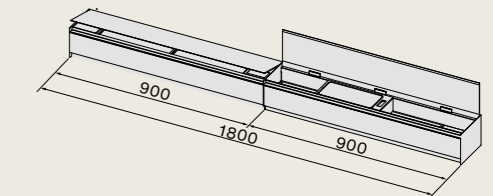

Accessories

Cutlery tray

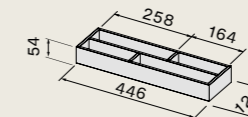
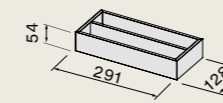
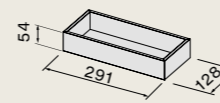

Knife rack

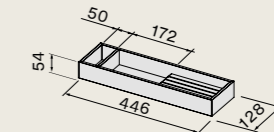

Cutting board

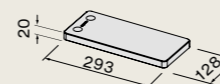

Spices tray

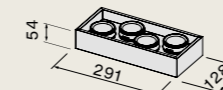

Accessory sockets / usb + electrical

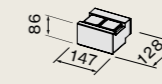

Configuration example (impilabili)

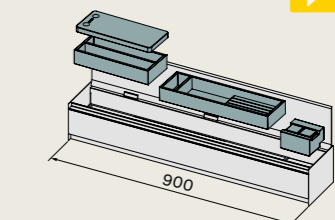

Air Wall

design Falmecc Lab, Magnetolab

Installation / Dimension

Wall
120 cm (central suction)
150 cm (right or left suction)

Features

Backlit white glass panel, painted white,
black matt aluminium profiles,
Flap di apertura manuale



Control

Touch control
3 velocità + Boost
Radiocomando opzionale
Dialogue system*

Lighting

Diffused light,
dimmerabile (4000 K)

Motor

Brushless 800 m³/h

Filtration

Carbon.Zeo (opzionale)

Energy Class

A++

*Connectivity: hood and induction hob.
Through the new Dialogue System, it is possible
to control the various functions of the hood directly
from the Falmecc induction hob.



EAN Code	Code	Description
8034122365312	CSHN00.01P8#ZZZB490F	Corpo cappa*
8034122713472	KACL.1007#NRSFF	Module panel 120 cm central suction
8034122713489	KACL.1008#NRSFF	Module panel 150 cm right suction
8034122713496	KACL.1009#NRSFF	Module panel 150 cm left suction

*Il sistema è composto sempre
da corpo cappa + modulo pannello,
da ordinare separatamente.



Accessories

8034122713762	KACL.1022#HF	Double shelf spice rack accessory
8034122713779	KACL.1023#HF	Accessory shelf with ladle holder
8034122713786	KACL.1024#HF	Book/tablet shelf accessory
8034122713793	KACL.1025#HF	Accessory shelf with glass rack
8034122708324	KACL.930	Carbon.Zeo filter
8034122711843	KACL.951	Filtro carbone alveolare h60
8034122712017	KACL.955	Griglia filtro h60
8034122708317	105080053	Remote control

Accessori

Air Wall 120

Module panel 120 cm
central suction

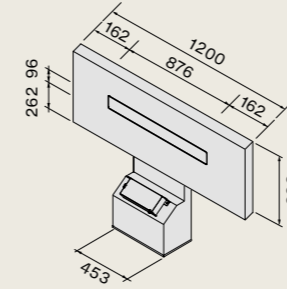

Air Wall 150

Module panel 150 cm
left suction

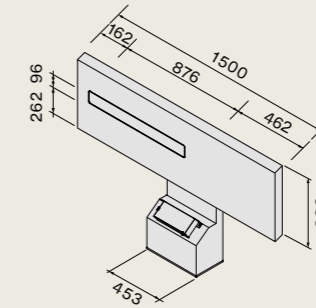

Module panel 150 cm
right suction

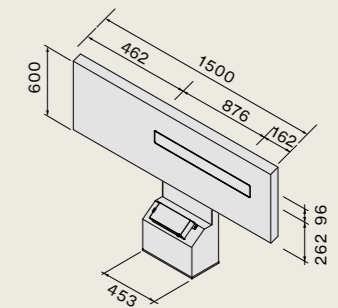

Suction version

lateral view

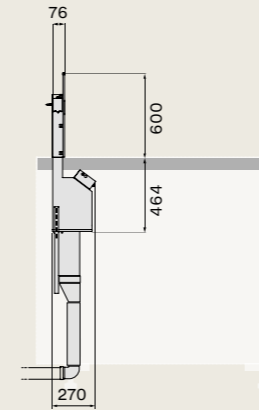

Filtering version

lateral view

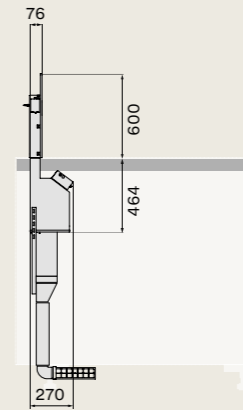

cut-out on top

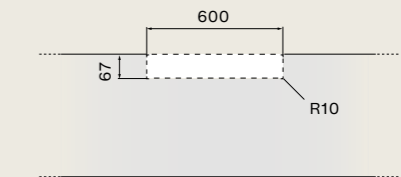

Accessories

Double shelf spice rack accessory

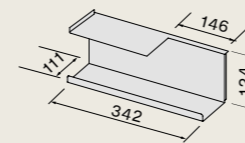

Book/tablet shelf accessory

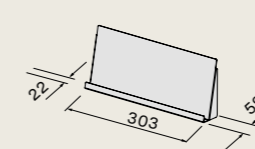

Accessory shelf with ladle holder

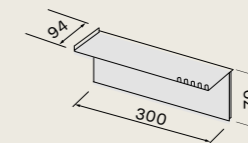

Accessory shelf with glass rack

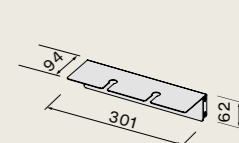

Falmec S.p.A

via dell'Artigianato, 42 z.i.
31029 Vittorio Veneto
Treviso — Italy
info@falmec.com
falmec.com

Images
Nudesign

Styling
Eye Studio/Beppe Mangia

Graphic Design
Designwork

Texts
Daniele Varelli

*Post-production photos
and color separation*
Luce Group

Printed in Italy
©June 2023
Europrint - Imoco Group