

Frame

Kitchens & workbenches

Salvatore Indriolo, 2018

 **ADI
DESIGN
INDEX**
Selezione Compasso d'Oro

archiproducts
AWARDS
WINNER

archiproducts
AWARDS
WINNER
SUSTAINABILITY



[> go to the outdoor version](#)

Bases / Basi / Basen

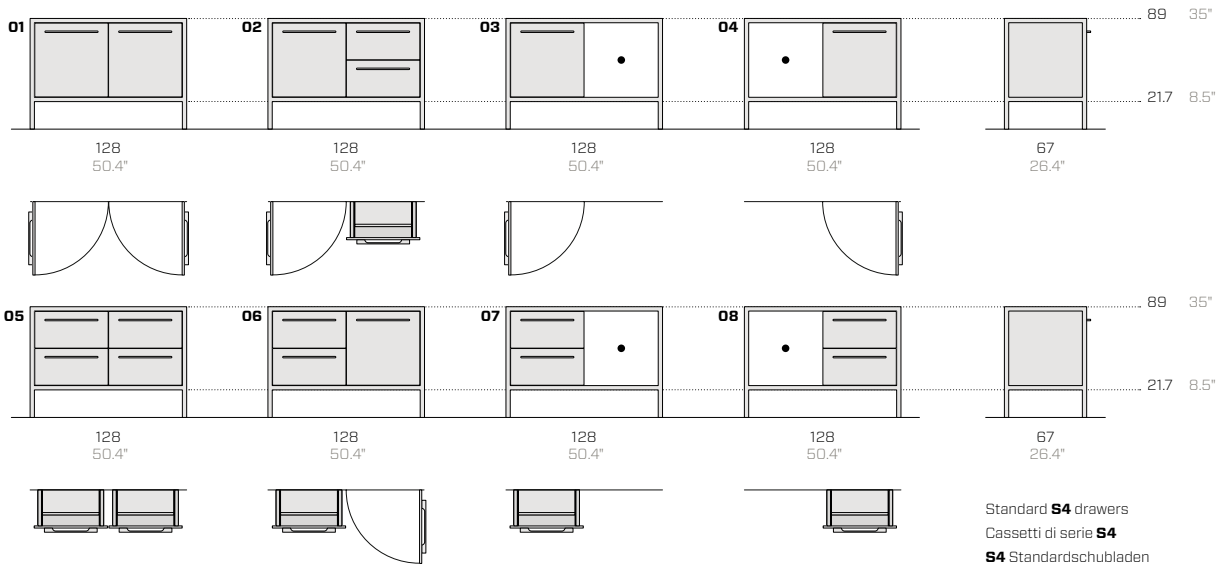

- Compartment for household appliances without Fantin door / Vano per elettrodomestici senza anta Fantin / Fach für Haushaltsgeräte ohne Fantin-Tür

Tops (illustrated with a sink on the left) / Top (illustrati con vasca a sinistra) / Arbeitsplatten (abgebildet mit Becken auf der linken Seite)

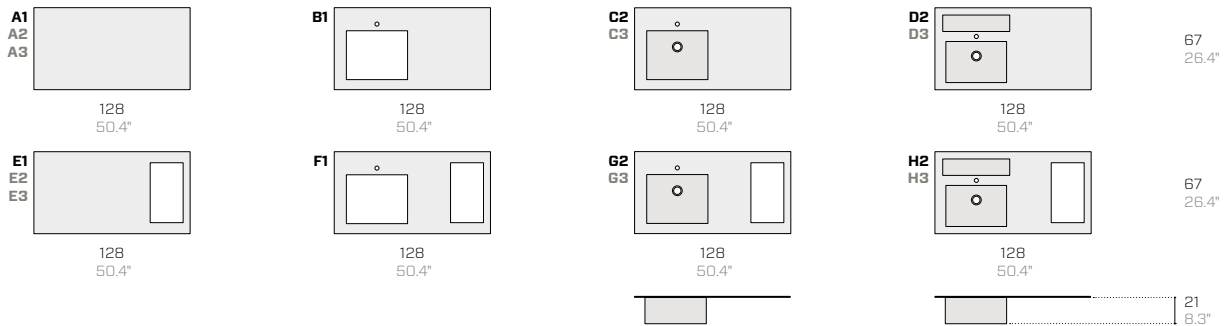

D, H with SST equipment channel / D, H con canale attrezzato in inox / D, H mit vorgerüstetem Abfluss aus Edelstahl

Useful measurements of the stainless steel top / Quote utili del top in inox / Nützliche Maßen der Edelstahlplatte

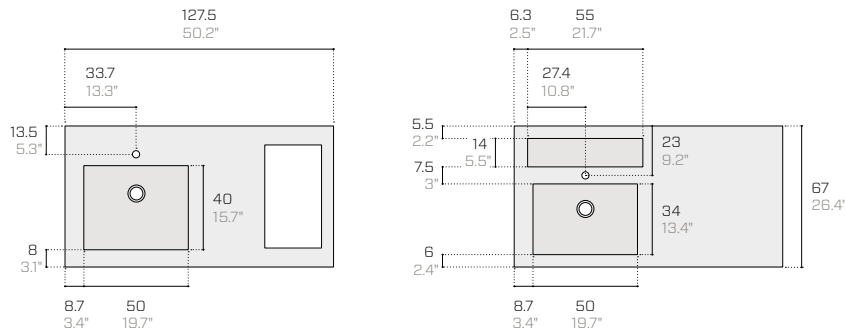

- See the section to the right for more information.
- Per altre informazioni, vedi a destra.
- Weitere Informationen finden Sie auf der rechten Seite.

Product / Prodotto / Produkt

Packaging / Imballo / Verpackung

No.	Code	Dimensions (w-d-h)	Weight	Dimensions (w-d-h)	Weight	Vol pkg
Nr.	Codice	Dimensioni (l-p-h)	Peso	Dimensioni (l-p-h)	Peso	Vol. collo
Nr.	Code	Abmessungen (b-t-h)	Gewicht	Abmessungen (b-t-h)	Gewicht	Vol. Kollo
:	:	cm	kg	cm	kg	mc

Bases / Basi / Basen

01	FR85	128 67 89	60	150 80 107	92	1.30
02	FR91D	128 67 89	70	150 80 107	102	1.30
03	FR84S	128 67 89	55	150 80 107	87	1.30
04	FR84D	128 67 89	55	150 80 107	87	1.30
05	FR93	128 67 89	60	150 80 107	112	1.30
06	FR91S	128 67 89	70	150 80 107	102	1.30
07	FR92S	128 67 89	65	150 80 107	97	1.30
08	FR92D	128 67 89	65	150 80 107	97	1.30

Glass top / Top in vetro / Arbeitsplatte aus Glas

A1	FRV01A	128 67 0.6	12.5	143 82 12	20	0.20
B1	FRV09A	128 67 0.6	12.0	143 82 12	19	0.20
E1	FRV03A	128 67 0.6	12.0	143 82 12	19	0.20
F1	FRV10A	128 67 0.6	12.5	143 82 12	20	0.20

Satin finish stainless steel top / Top in acciaio inox satinato / Arbeitsplatte aus Edelstahl mit Satin-Finish

A2	FRX201S	128 67 0.4	27	137 80 21	37	0.30
C2	FRX203S	128 67 0.4	25	137 80 50	35	0.60
D2	FRX221S	128 67 0.4	27	137 80 50	37	0.60
E2	FRX202S	128 67 0.4	23	137 80 21	33	0.30
G2	FRX204S	128 67 0.4	22	137 80 50	32	0.60
H2	FRX222S	128 67 0.4	25	137 80 50	35	0.60

Vintage finish stainless steel top (Barazza) / Top in acciaio inox Vintage (Barazza) / Arbeitsplatte aus Edelstahl mit Vintage-Finish (Barazza)

A3	FRB41V	128 67 0.4	27	137 80 21	37	0.30
C3	FRB45V	128 67 0.4	25	137 80 50	35	0.60
D3	FRB94V	128 67 0.4	27	137 80 50	37	0.60
E3	FRB43V	128 67 0.4	23	137 80 21	33	0.30
G3	FRB46V	128 67 0.4	22	137 80 50	32	0.60
H3	FRB95V	128 67 0.4	25	137 80 50	35	0.60

Upstand (stainless steel, satin and Vintage finish) / Alzatina (acciaio inox, satinato o Vintage) / Wischleiste (Edelstahl, satin- und Vintage-Finish)

-	FRX217S	128 0.4 4	2.5	137 2 10	3	0.10
-	FRB81V	128 0.4 4	2.5	137 2 10	3	0.10

• Scan the QR code to the side to find out more about fitting the hobs in holes in the tops. Fantin shall accept no liability for the assembly and installation of other appliances. If you wish to install other appliances, download the document that is available here and consult it with a qualified fitter.

• Dal QR-Code qui a fianco è possibile approfondire le forature dei top per l'installazione dei piani cottura a listino. Fantin non si assume responsabilità per montaggio e installazione di altri elettrodomestici. In tal caso, si consiglia di consultare il documento qui scaricabile con un installatore qualificato.

• Über den QR-Code auf der rechten Seite können Sie mehr über die Bohrungen für den Einbau der Kochfelder erfahren. Fantin übernimmt keine Haftung für die Montage und Installation anderer Küchengeräte. In diesem Fall empfehlen wir, die Beschreibung, die hier heruntergeladen werden kann, mit einem qualifizierten Installateur zu konsultieren.



Bases / Basi / Basen

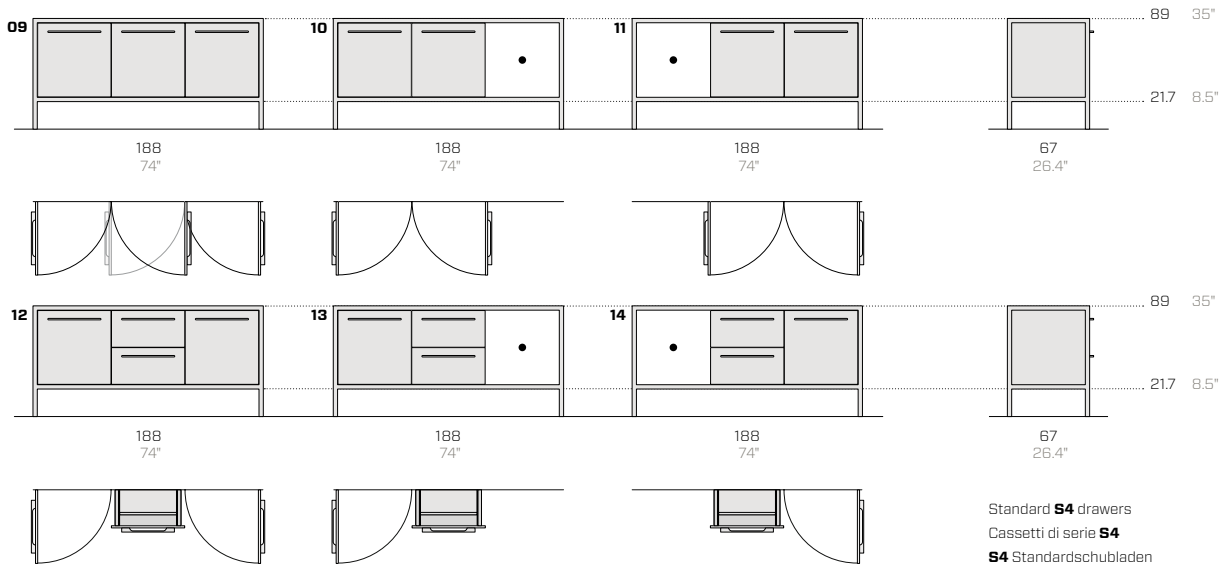

- Compartment for household appliances without Fantin door / Vano per elettrodomestici senza anta Fantin / Fach für Haushaltsgeräte ohne Fantin-Tür

Tops (illustrated with a sink on the left) / Top (illustrati con vasca a sinistra) / Arbeitsplatten (abgebildet mit Becken auf der linken Seite)

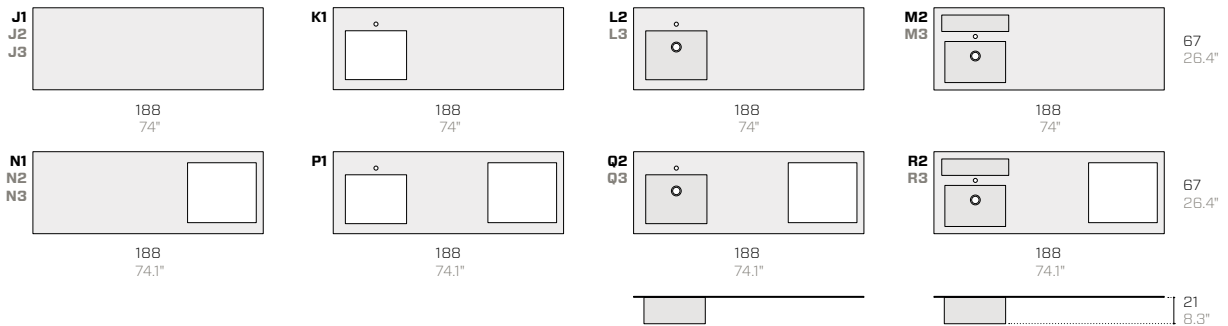

M, R with SST equipment channel / M, R con canale attrezzato in inox / M, R mit vorgerüstetem Abfluss aus Edelstahl

Useful measurements of the stainless steel top / Quote utili del top in inox / Nützliche Maßen der Edelstahlplatte

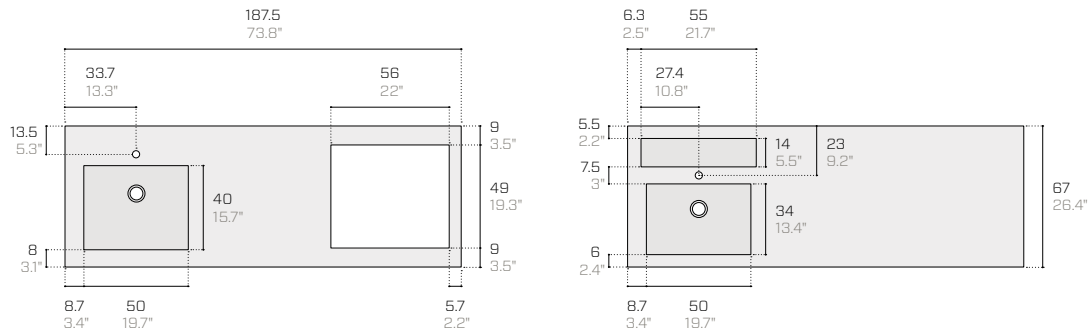

Product / Prodotto / Produkt

Packaging / Imballo / Verpackung

No.	Code	Dimensions (w-d-h)	Weight	Dimensions (w-d-h)	Weight	Vol pkg
Nr.	Codice	Dimensioni (l-p-h)	Peso	Dimensioni (l-p-h)	Peso	Vol. collo
Nr.	Code	Abmessungen (b-t-h)	Gewicht	Abmessungen (b-t-h)	Gewicht	Vol. Kollo
		cm	kg	cm	kg	mc

Bases / Basi / Basen

09	FR87	188 67 89	92	200 80 107	135	1.80
10	FR86S	188 67 89	87	200 80 107	130	1.80
11	FR86D	188 67 89	87	200 80 107	130	1.80
12	FR83	188 67 89	102	200 80 107	145	1.80
13	FR82S	188 67 89	97	200 80 107	140	1.80
14	FR82D	188 67 89	97	200 80 107	140	1.80

Glass top / Top in vetro / Arbeitsplatte aus Glas

J1	FRV05A	188 67 0.6	18.5	203 82 12	29	0.20
K1	FRV11A	188 67 0.6	18.0	203 82 12	28	0.20
N1	FRV07A	188 67 0.6	18.0	203 82 12	28	0.20
P1	FRV12A	188 67 0.6	18.5	203 82 12	29	0.20

Satin finish stainless steel top / Top in acciaio inox satinato / Arbeitsplatte aus Edelstahl mit Satin-Finish

J2	FRX209S	188 67 0.4	40	197 80 21	50	0.40
L2	FRX211S	188 67 0.4	38	197 80 50	48	0.80
M2	FRX225S	188 67 0.4	39	197 80 50	49	0.80
N2	FRX210S	188 67 0.4	31	197 80 21	41	0.40
Q2	FRX212S	188 67 0.4	30	197 80 50	40	0.80
R2	FRX226S	188 67 0.4	35	197 80 50	45	0.80

Vintage finish stainless steel top (Barazza) / Top in acciaio inox Vintage (Barazza) / Arbeitsplatte aus Edelstahl mit Vintage-Finish (Barazza)

J3	FRB71V	188 67 0.4	40	197 80 21	50	0.40
L3	FRB75V	188 67 0.4	38	197 80 50	48	0.80
M3	FRB98V	188 67 0.4	39	197 80 50	49	0.80
N3	FRB73V	188 67 0.4	31	197 80 21	41	0.40
Q3	FRB76V	188 67 0.4	30	197 80 50	40	0.80
R3	FRB99V	188 67 0.4	35	197 80 50	45	0.80

Upstand (stainless steel, satin and Vintage finish) / Alzatina (acciaio inox, satinato o Vintage) / Wischleiste (Edelstahl, satin- und Vintage-Finish)

-	FRX219S	188 0.4 4	3.5	197 2 10	4	0.10
-	FRB82V	188 0.4 4	3.5	197 2 10	4	0.10

Useful measurements / Quote utili / Nützliche Maßen

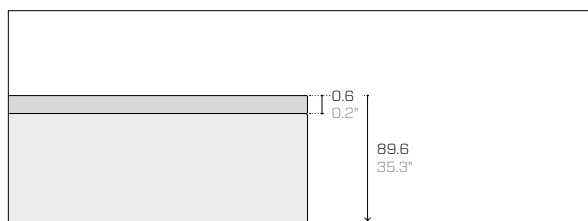

Glass top / Top in vetro / Arbeitsplatte aus Glas

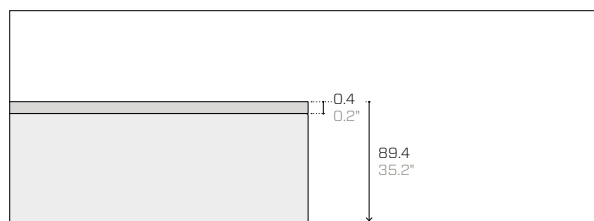

Stainless steel top / Top in acciaio inox / Arbeitsplatte aus Edelstahl

Stainless steel accessories for tops / Accessori in inox per top / Zubehör aus Edelstahl für die Arbeitsplatten

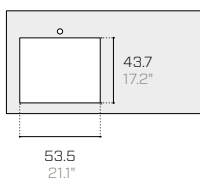
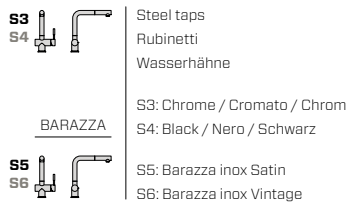
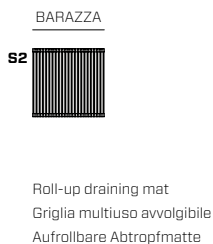
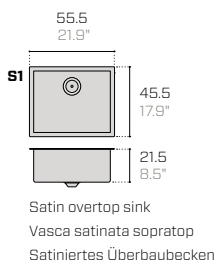

Hole size for the S1 sink
Foratura top per vasca S1
Größe der Bohrungen für Beck S1

SST accessories for the equipment channel / Accessori in inox per canale attrezzato / Zubehör aus Edelstahl für vorgerüsteten Abfluss

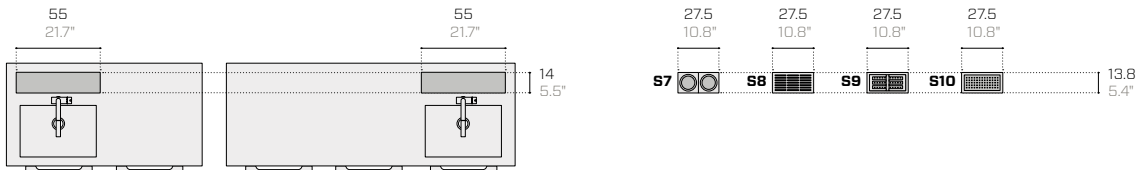

The equipment channel (H 20 cm) can hold a choice of 2 different items. Satin-finish AISI 304 stainless steel channel and accessories.
Il canale attrezzato (H 20 cm) contiene 2 accessori combinabili a scelta. Canale e accessori in acciaio inox AISI 304 satinato.
Der vorgerüstete Abfluss (H 20 cm) umfasst 2 Zubehörteile, die wahlweise kombiniert werden können. Abfluss und Zubehör aus satiniertem Edelstahl AISI 304.



Bottle rack (H 17 cm; 2 pieces)
Portabottiglie (H 17 cm; 2 elementi)
Flaschenhalter (H 17 cm; 2 Elemente)



Glass drainer (H 1.5 cm)
Scolabicchieri (H 1.5 cm)
Abtropfgitter (H 1.5 cm)



Dish drainer (H 7 cm)
Scolapiatti (H 7 cm)
Abtropfgestell (H 7 cm)



Sink (H 7 cm)
Vaschetta (H 7 cm)
Wanne (H 7 cm)

Product / Prodotto / Produkt					Packaging / Imballo / Verpackung					
No.	Code	Dimensions (w-d-h)			Weight	Dimensions (w-d-h)			Weight	Vol pkg
Nr.	Codice	Dimensioni (l-p-h)			Peso	Dimensioni (l-p-h)			Peso	Vol. collo
Nr.	Code	Abmessungen (b-t-h)			Gewicht	Abmessungen (b-t-h)			Gewicht	Vol. Kollo
		cm			kg	cm			kg	mc
Overtop sink in inox satin / Vasca sopra-top in inox satinato / Überbaubecken in inox Satin										
S1	FRB20S	55.5	45.5	21.5	6.5	59.5	49.5	27	8.5	0.10
Roll-up draining mat / Griglia multiuso avvolgibile / Aufrollbare Abtropfmatte										
S2	FRB11	47	45	1	1	50	8	8	1	0.10
Steel taps / Rubinetti / Wasserhähne										
S3	FRB10C	13	26	27	3	59	25	10	4	0.10
S4	FRB10N	13	26	27	3	59	25	10	4	0.10
S5	FRB10S	13	26	27	3	59	25	10	4	0.10
S6	FRB10V	13	26	27	3	59	25	10	4	0.10
SST accessories for the equipment channel / Accessori in inox per canale attrezzato / Zubehör aus Edelstahl für vorgerüsteten Abfluss										
S7	FRB13S	27.5	13.8	17.0	1.0	30	46	12	1.2	0.10
S8	FRB14S	27.5	13.8	1.5	0.3	34	18	4	0.5	0.10
S9	FRB15S	27.5	13.8	7.0	1.3	30	23	12	1.5	0.10
S10	FRB16S	27.5	13.8	7.0	1.0	30	23	12	1.2	0.10
Back panels for freestanding kitchen / Schiene per cucina freestanding / Rückwände für freistehende Küche										
-	FRK01S1	120	3	60	6	124	64	7	7	0.10
-	FRK02S2	180	3	60	9	184	64	7	10	0.10
Floor attachment cover kit / Kit di copertura allacciamenti a pavimento / Set für Abdeckung der Anschlüsse am Boden										
-	FRK03A1	60	20	25	3	62	22	27	5	0.10



Drawer kits / Kit cassetti / Schubladen-Set

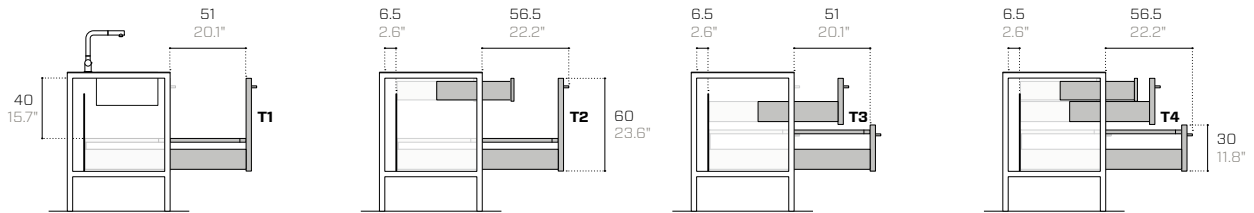

T1
Kit 1 large drawer
Kit 1 cassettone
Set 1 Kommode

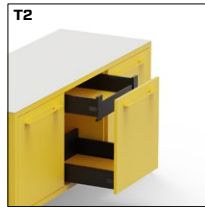

T2
Kit 1 large drawer + 1 inner drawer
Kit 1 cassettone + cassetto interno
Set 1 Kommode + 1 Innenfach

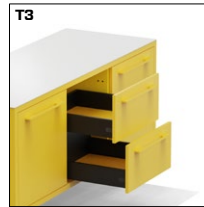

T3
Kit 2 drawers
Kit 2 cassetti
Set 2 Schubladen

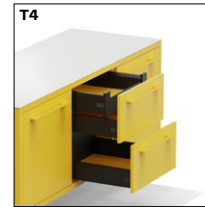

T4
Kit 2 drawers + 1 inner drawer
Kit 2 cassetti + cassetto interno
Set 2 Schubladen + 1 Innenfach

Wheel kit with colour-matching discs / Kit ruote con dischi in tinta / Radsatz mit farblich abgestimmten Scheiben

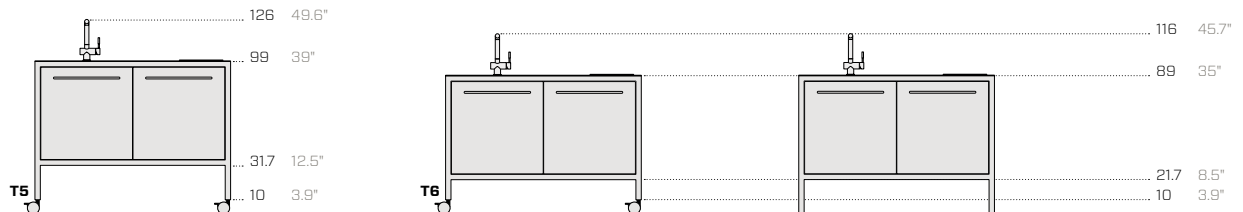

Kitchen height (with wheels)
Altezza cucina (con ruote)
Küchenhöhe (mit Rädern)

Kitchen with wheel kit and resized legs (same overall height as the kitchen without wheel kit)
Cucina con kit ruote e gambe ridimensionate (stessa altezza complessiva della cucina senza kit ruote)
Küche mit Radsatz und verkleinerte Beine (gleiche Gesamthöhe wie der Küche ohne Radsatz)



T5

Product / Prodotto / Produkt

Packaging / Imballo / Verpackung

No.	Code	Dimensions (w-d-h)	Weight	Dimensions (w-d-h)	Weight	Vol pkg
Nr.	Codice	Dimensioni (l-p-h)	Peso	Dimensioni (l-p-h)	Peso	Vol. collo
Nr.	Code	Abmessungen (b-t-h)	Gewicht	Abmessungen (b-t-h)	Gewicht	Vol. Kollo
		cm	kg	cm	kg	mc

Drawer kits (surcharge on the door price) / Kit cassetti (sovrapprezzo costo anta) / Schubladen-Set (Zuschlag auf den Türpreis)

T1	FRK21C1	60 55 60	13	63 58 63	14	0.30
T2	FRK20C2	60 55 60	18	63 58 63	19	0.30
T3	FRK22C2	60 55 60	15	63 58 63	16	0.30
T4	FRK23C3	60 55 60	20	63 58 63	21	0.30

Aluminum cutlery dividers / Divisori portaposate in alluminio / Besteckteiler aus aluminium

-	FRK14DP	48 8 5	1	50 10 6	1	0.10
---	---------	--------	---	---------	---	------

Waste separation systems / Kit di contenitori per raccolta differenziata / Abfalltrennsystem

-	FRK61DIF	44 29 22	3	50 10 6	4	0.10
-	FRK60DIF	46 30 30	2	50 10 6	3	0.10

Additional shelf / Ripiano aggiuntivo / Zusätzlicher Einlegeboden

-	FRK10R1	57 46 2	3	50 10 6	3	0.10
---	---------	---------	---	---------	---	------

Wheel kit with colour-matching discs / Kit ruote con dischi in tinta / Radsatz mit farblich abgestimmten Scheiben

T5	FRK31R8	8 3.5 10	2	20 10 10	3	0.10
T6	FRK33R8	8 3.5 10	2	20 10 10	3	0.10

Other useful measurements / Altre quote utili / Andere nützliche Maßen

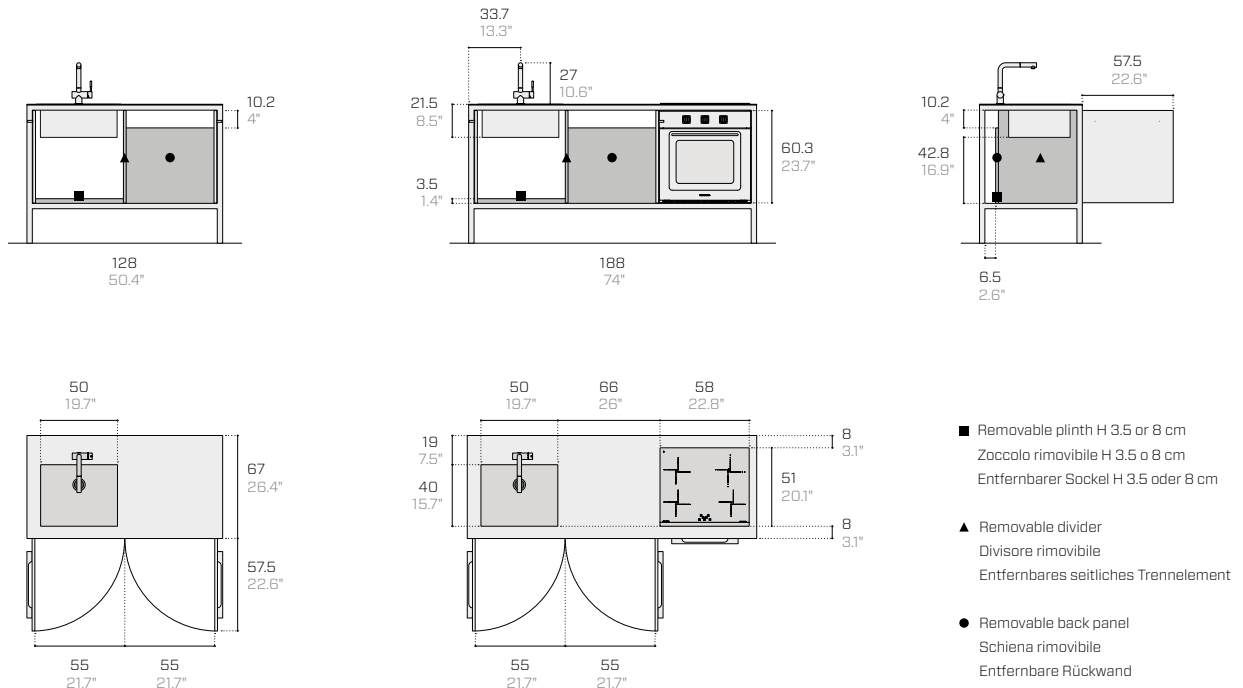

Shelf / Mensola / Regalbrett

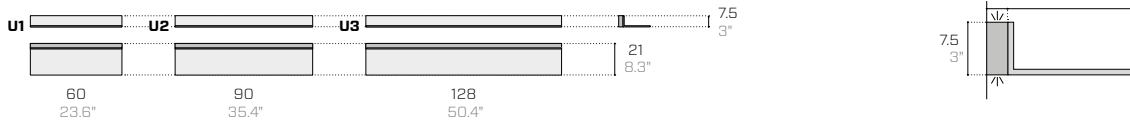

U3 compatible with 3000K LED bar / U3 compatibile con barra LED 3000K / U3 kompatibel mit 3000K LED Bar

Open compartment / Vano a giorno / Offenes Fach

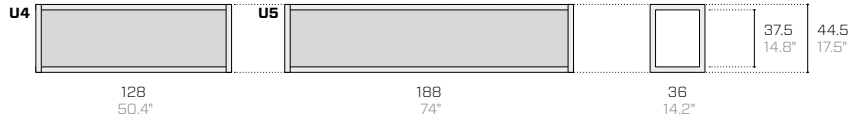
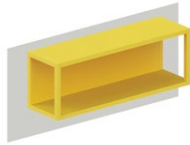

Wall panelling / Boiserie a parete / Wandverkleidungen

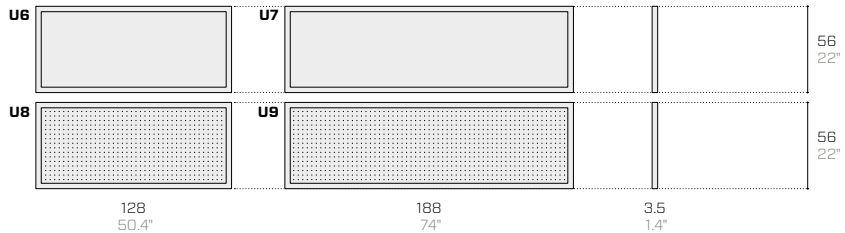

Wall panelling with shelf / Boiserie a parete con mensola / Wandverkleidungen mit Regal

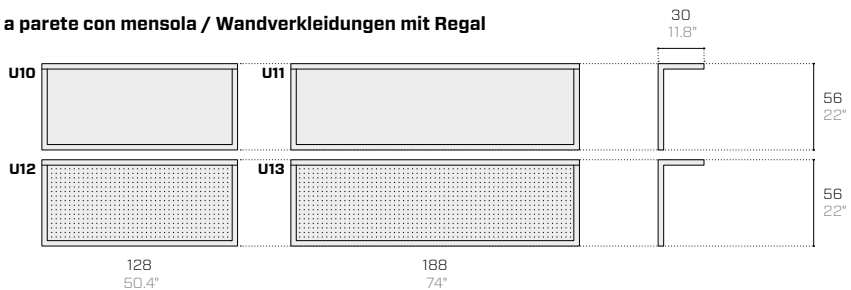

Items compatible with 3000K LED bar / Modelli compatibili con barra LED 3000K / Modelle kompatibel mit 3000K LED Bar

Useful measurements / Quote utili / Nützliche Maßen

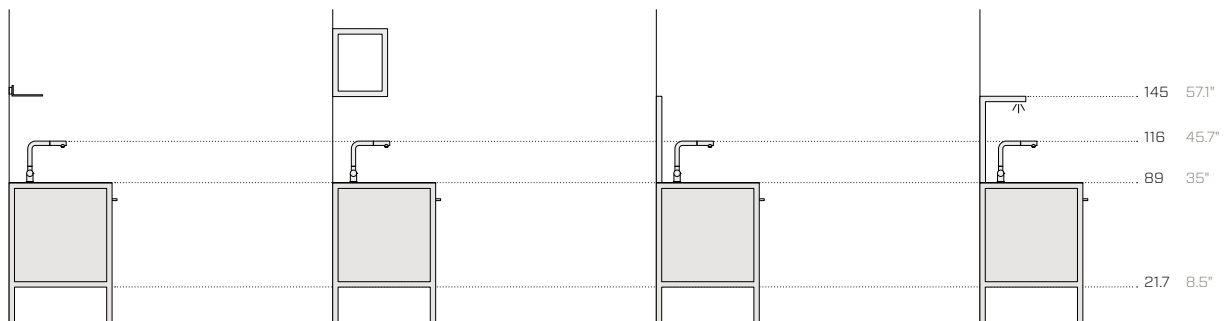

U1 / U2 / U3

Free scope for wall mounting
Fissaggio libero a parete
Freie Wandmontage

U4 / U5

Free scope for wall mounting
Fissaggio libero a parete
Freie Wandmontage

U6 / U7 / U8 / U9

Free scope for wall mounting
Fissaggio libero a parete
Freie Wandmontage

U10 / U11 / U12 / U13

Attachment to kitchen and wall
Fissaggio alla cucina e alla parete
Montage an Herd und Wand

Product / Prodotto / Produkt

No.	Code	Dimensions (w-d-h)			Weight	Max capacity
Nr.	Codice	Dimensioni (l-p-h)			Peso	Capacità max
Nr.	Code	Abmessungen (b-t-h)			Gewicht	Max. Tragfähigkeit
		cm			kg	kg

Shelf / Mensola / Regalbrett

U1	FRM13	60	21	7.5	4.0	6
U2	FRM14	90	21	7.5	6.0	9
U3	FRM15	128	21	7.5	8.5	12

Open compartment / Vano a giorno / Offenes Fach

U4	FRM11	128	36	44.5	30	30
-	FRM16	158	36	44.5	38	38
U5	FRM12	188	36	44.5	45	45

Solid sheet metal wall panelling / Boiserie a parete in lamiera piena / Wandverkleidung

U6	FRM07	128	3.5	56	14	-
U7	FRM08	188	3.5	56	20	-

Perforated sheet metal wall panelling / Boiserie a parete in lamiera forata / Wandverkleidungen

U8	FRM09	128	3.5	56	13	-
U9	FRM10	188	3.5	56	19	-

Solid sheet metal wall panelling with shelf / Boiserie a parete in lamiera piena con mensola

U10	FRM01	128	30	56	18	30
U11	FRM02	188	30	56	27	45

Perforated sheet metal wall panelling with shelf / Boiserie a parete in lamiera forata con mensola

U12	FRM05	128	30	56	17	30
U13	FRM06	188	30	56	26	45

LED bar 3000K (10W per meter) / Barra LED 3000K (10W per metro) / LED-Lichtleiste

-	FRS128L3	121	3.5	3.5	0.2	-
-	FRS188L3	181	3.5	3.5	0.3	-

24V-20W Power supply kit / Kit con alimentatore 24V-20W / Netzteil 24V-20W

-	FRSK1LPS	-	-	-	0.2	-
---	----------	---	---	---	-----	---

Magnetic dimmer switch / Interruttore dimmer magnetico / Magnetischer Dimmer

-	FRSK6D	2	7	2	0.2	-
---	--------	---	---	---	-----	---

Kit of 5 hooks / Kit di 5 gancetti / Kit mit 5 Haken

-	FRK29GA	-	-	-	0.1	-
---	---------	---	---	---	-----	---

Kit of 5 magnets / Kit di 5 calamite / Kit mit 5 Magneten

-	FRK28CA	-	-	-	0.1	-
---	---------	---	---	---	-----	---

Packaging / Imballo / Verpackung

Dimensions (w-d-h)			Weight	Vol pkg
Dimensioni (l-p-h)			Peso	Vol. collo
Abmessungen (b-t-h)			Gewicht	Vol. Kollo
cm			kg	mc

70	30	20	5.0	0.10
100	30	20	7.0	0.10
140	30	20	9.5	0.10

140	40	10	32	0.10
170	40	10	40	0.10
200	40	10	47	0.10

Pan aus Vollblech

140	60	10	17	0.10
200	60	10	23	0.20

Verkleidungen aus Lochblech

140	60	10	16	0.10
200	60	10	22	0.20

Verkleidungen aus Vollblech mit Regal

140	60	40	21	0.40
200	60	40	31	0.50

Verkleidungen aus Lochblech mit Regal

140	60	40	20	0.40
200	60	20	30	0.30

Verkleidungen aus Lochblech mit Regal

124	6.5	6.5	0.2	0.10
184	6.5	6.5	0.3	0.10

-	-	-	0.2	-
---	---	---	-----	---

5	10	5	0.3	0.10
---	----	---	-----	------

-	-	-	0.1	-
---	---	---	-----	---

-	-	-	0.1	-
---	---	---	-----	---

◀ U10 / U11 / U12 / U13

For glass tops, attachment to the wall only / Per top in vetro, fissaggio solo alla parete / Für die Arbeitsplatte aus Glas nur Wandmontage

Hobs / Piani cottura / Kochfelder

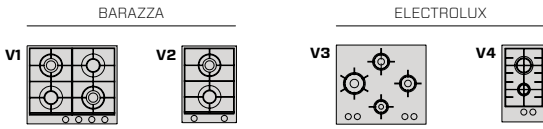

Gas hobs
Piani cottura a gas
Gaskochfelder

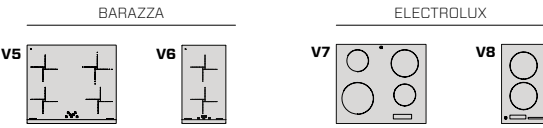

Electric induction hobs
Piani cottura elettrici a induzione
Elektrische Induktionskochfelder

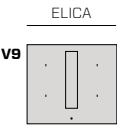

Electric induction hob with integrated filtering hood
Piano cottura elettrico a induzione con cappa integrata filtrante
Elektrisches Induktionskochfeld mit integrierter Filterhaube

Shelf with integrated Falmecc hood / Mensola con cappa Falmecc integrata / Regalbrett mit integrierter Filterhaube Falmecc

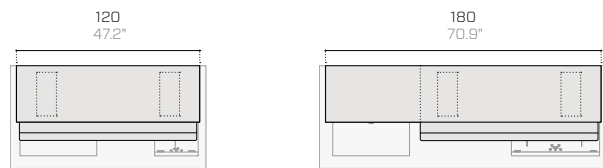
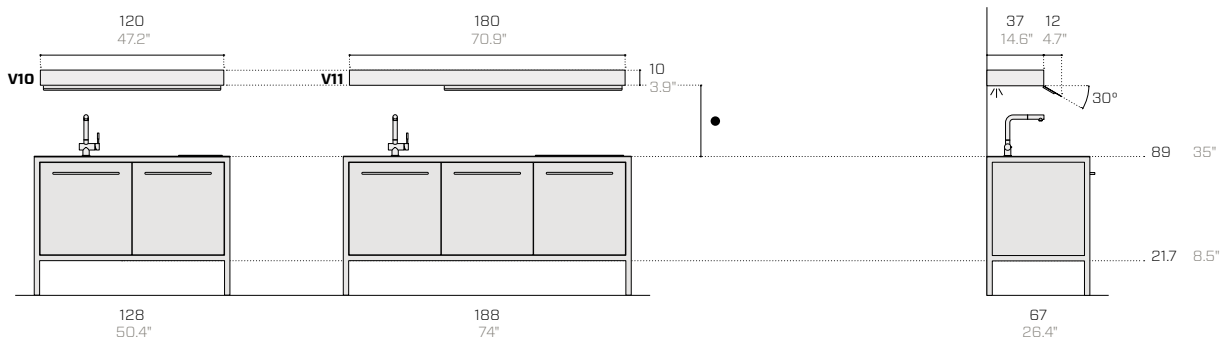

- It must be installed at least 62 cm above gas hobs and 52 cm above induction hobs. On the shelf with a width of 180 cm, the extractor can be positioned on the left or the right.
- L'installazione minima è 62 cm sopra i piani a gas e 52 cm sopra i piani a induzione. Nella mensola L180 cm, l'aspirazione è posizionabile a sinistra oppure a destra.
- Die erforderliche Mindesthöhe für die Installation beträgt 62 cm über Gaskochfeldern und 52 cm über Induktionskochfeldern. Bei dem 180 cm langen Regalbrett kann der Dunstabzug auf der linken oder auf der rechten Seite positioniert werden.

Product / Prodotto / Produkt

Packaging / Imballo / Verpackung

No.	Code	Brand code	Dimensions (w-d-h)			Weight	Dimensions (w-d-h)			Weight
N.	Codice	Codice marca	Dimensioni (l-p-h)			Peso	Dimensioni (l-p-h)			Peso
Nr.	Code	Herstellercode	Abmessungen (b-t-h)			Gewicht	Abmessungen (b-t-h)			Gewicht
			cm			kg	cm			kg

Gas hobs / Piani cottura a gas / Gaskochfelder

V1	FRE32	1PBF64	58.5	51.0	9.5	12	68	58	16.5	15
V2	FRE31	1PBF2	36.0	51.0	10.0	6	44	58	18.5	10
V3	FRE54	KGU643723Z	59.5	52.5	6.5	12	71	62	16.0	14
V4	FRE21	EGG3222N	29.0	51.0	6.5	5	48	62	15.0	7

Electric induction hobs / Piani cottura elettrici a induzione / Elektrische Induktionskochfelder

V5	FRB05-F4	1PIDC60N	58.0	51.0	5.4	8	67	60	12.5	10
V6	FRB06-F2	1PIDC30N	28.5	50.5	5.4	5	39	60	13.0	6
V7	FRE48	KIB60424CK	59.0	52.0	6.5	12	80	60	15.0	14
V8	FRE02	LIT30231C	27.0	49.0	6.5	6	48	60	15.0	8

Aspirating induction hob (w. installation kit) / Piano induzione aspirante (con kit di installazione) / Induktionskochfeld mit Dunstabzug (mit Einbausatz)

V9	FRE37	PRF0167053	60	51.5	26	20	80	60	30	22
-----------	-------	------------	----	------	----	----	----	----	----	----

Kit for aspirating induction hob / Kit per piano induzione aspirante / Bausatz für Induktionskochfeld mit Dunstabzug

xV9	FRE37-KIT	-	-	-	-	2	-	-	-	2
------------	-----------	---	---	---	---	---	---	---	---	---

Shelf with integrated Falmecc hood / Mensola con cappa Falmecc integrata / Regalbrett mit integrierter Filterhaube Falmecc

V10	FR97	-	120.5	38	10.5	30	130	47	40	35
V11	FR98	-	180.5	38	10.5	39	130	47	60	45

Frame kitchens are compatible with Miele appliances

Le cucine Frame sono compatibili con l'installazione di elettrodomestici Miele

Frame Herde sind mit der Installation von Geräten der Marke Miele kompatibel

Examples of compositions / Esempi di composizioni / Kompositionsbeispiele

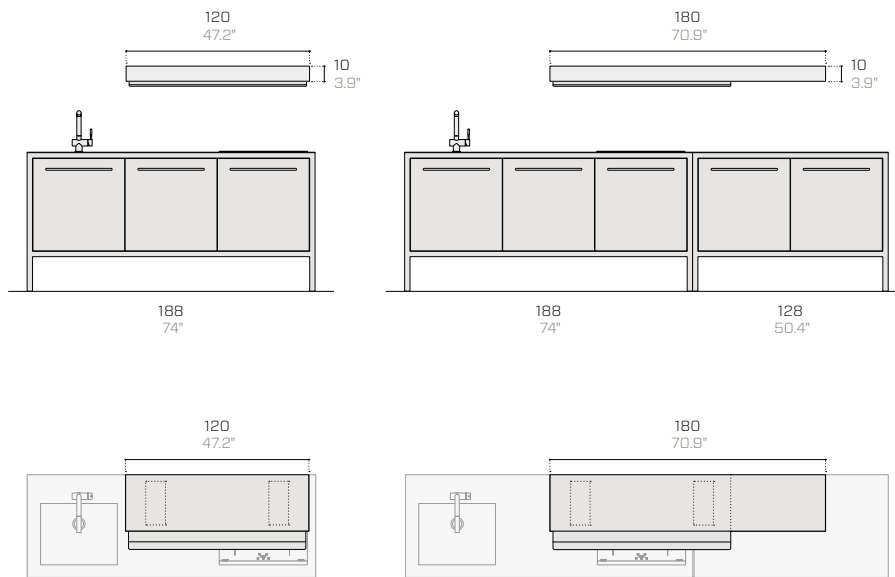

Custom width on request (with 60 or 90 cm pitch and with maximum width of the front cover - in the same color as the kitchen frame - of 220 cm).

Larghezza custom su richiesta (con passo 60 o 90 cm e con misura massima del carter frontale - in tinta con il telaio della cucina - di 220 cm).

Individuelle Breite auf Anfrage (bei 60 oder 90 cm Teilung und bei maximaler Breite der Frontabdeckung - in der gleichen Farbe wie der Küchenrahmen - von 220 cm).

Integrated appliances / Elettrodomestici a incasso / Einbaugeräte

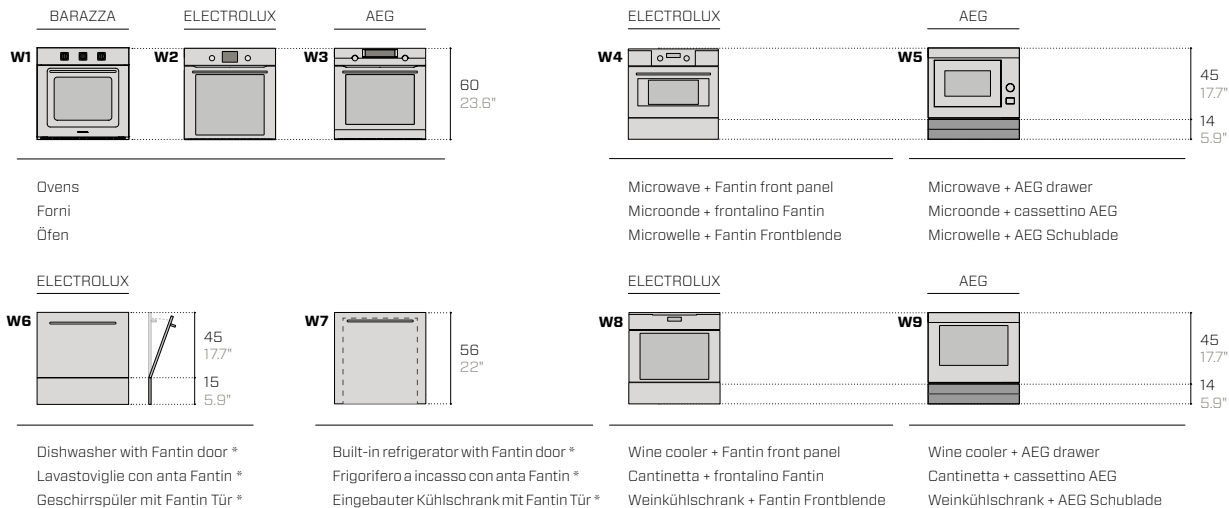

*Replacing an existing door / In sostituzione di un'anta esistente / Anstelle von einer vorhandenen Tür

Freestanding appliance kits / Kit per elettrodomestici a terra / Bausatz für die Bodenmontage von Haushaltsgeräten

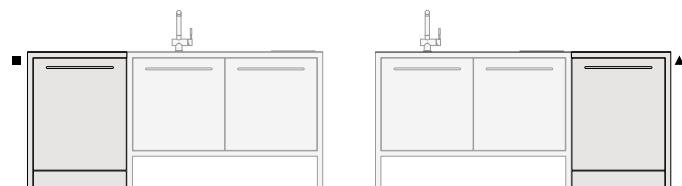
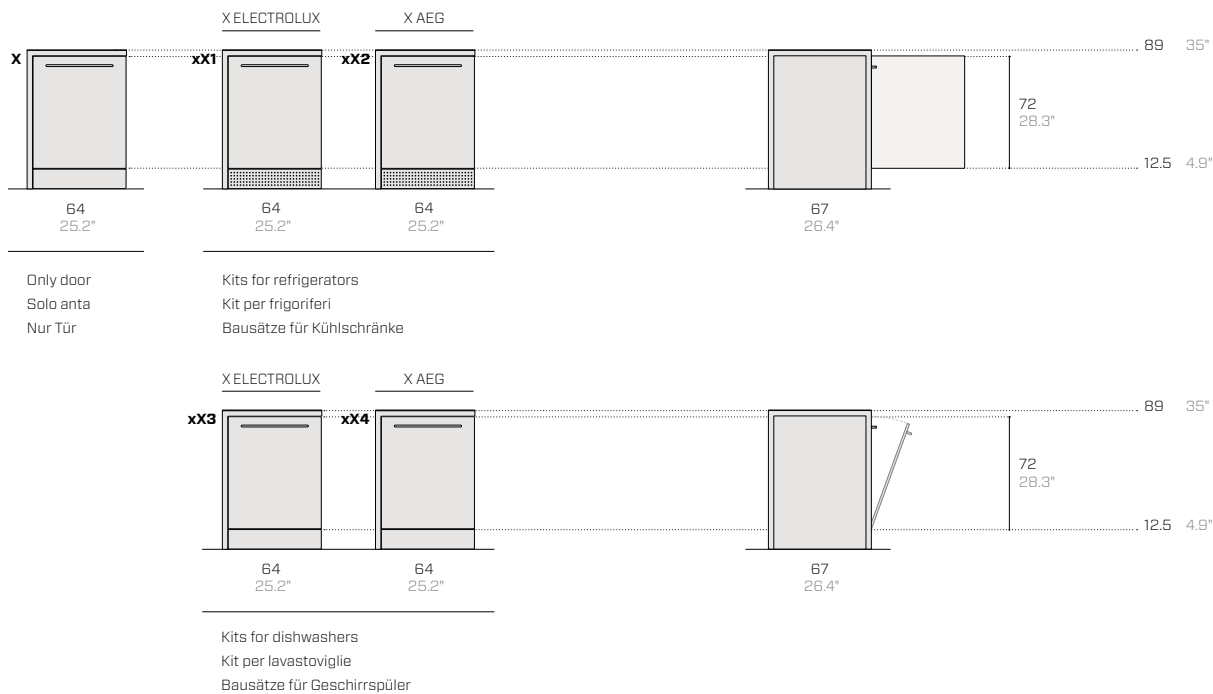

The kits can be placed on either the left [■] or the right [▲].

Il kit è posizionabile sia a sinistra [■] sia a destra [▲].

Der Bausatz kann sowohl links [■] als auch rechts [▲] positioniert werden.

Product / Prodotto / Produkt

Packaging / Imballo / Verpackung

No.	Code	Brand code	Dimensions (w-d-h)			Weight	Dimensions (w-d-h)			Weight
Nr.	Codice	Codice marca	Dimensioni (l-p-h)			Peso	Dimensioni (l-p-h)			Peso
Nr.	Code	Herstellercode	Abmessungen (b-t-h)			Gewicht	Abmessungen (b-t-h)			Gewicht
			cm			kg	cm			kg

Integrated appliances (with installation kit) / Elettrodomestici a incasso (con kit di installazione) / Einbaugeräte (mit Einbausatz)

W1	FRB02V-FV	1FUJAM	60	61	60	35	64	64	68	39
W2	FRE03	KOFFP46TX	60	60	55	33	64	64	68	37
W3	FRE49	BEK435E21M	60	60	55	33	64	64	68	37
W4	FRE46	KVMDE46X	60	56	60	40	66	54	53	31
W5	FRE11	MBE2658DEM	60	53	60	28	66	54	53	31
W6	FRE36	ESL2500RO	56	55	45	38	60	56	51	40
W7	FRE45	C600S	49	47	56	25	60	56	51	27
W8	FRE47	KBW5X	60	56	60	34	66	54	53	31
W9	FRE13	KWK884520M	60	53	60	28	66	54	53	31

Kits for integrated appliances / Kit per elettrodomestici a incasso / Bausätze für Einbaugeräte

xW1	FRB02V-KIT	-	2.0	7	58.0	2	10	10	84	3
xW2	FRE03-KIT	-	2.0	7	58.0	2	10	10	84	3
xW3	FRE49-KIT	-	2.0	7	58.0	2	10	10	84	3
xW4	FRE46-KIT	-	59.7	52	14.0	5	10	10	84	6
xW5	FRE11-KIT	-	2.0	7	58.0	2	10	10	84	3
xW6	FRE36-KIT	-	59.7	52	59.7	8	10	10	84	9
xW7	FRE45-KIT	-	59.7	10	59.7	7	10	10	84	8
xW8	FRE47-KIT	-	59.7	52	14.0	5	10	10	84	6
xW9	FRE13-KIT	-	2.0	7	58.0	2	10	10	84	3

Freestanding additional door kit / Kit anta aggiuntiva a terra / Bausatz für zusätzliche Tür am Boden

X	FRK13ET	-	64	67	89	18	67	70	92	23
----------	---------	---	----	----	----	----	----	----	----	----

Freestanding appliances (no kit) / Elettrodomestici a terra (senza kit) / Bodengeräte (ohne Bausatz)

[X1]	FRE55	KSB2AE82S	56.0	55	82	31	63	63	87	33
[X2]	FRE56	OSF6I82EF	56.0	55	82	35	63	63	87	37
[X3]	FRE43	KESC8300L	59.5	55	82	37	63	63	87	38
[X4]	FRE57	FSK73617Z	59.5	55	82	37	63	63	87	38

Freestanding appliance kits / Kit per elettrodomestici a terra / Bausatz für Bodengeräte

xx1	FRE55-KIT	-	64	67	89	18	67	70	92	23
xx2	FRE41-KIT	-	64	67	89	18	67	70	92	23
xx3	FRE56-KIT	-	64	67	89	18	67	70	92	23
xx4	FRE57-KIT	-	64	67	89	18	67	70	92	23

• Scan the QR code to find out more about the assembly and installation kits for the appliances in the table (included in the prices of the appliances themselves or available for purchase separately). Fantin shall accept no liability for the assembly and installation of other appliances. If you wish to install other appliances, download the document that is available here and consult it with a qualified fitter. Frame Kitchens are compatible with Miele appliances whose dimensions match the details given in the document that can be downloaded by scanning the QR code. For appliances of this kind, Fantin is prepared to consider making an assembly kit, once it has been given the specific technical installation guide.

• Dal QR-Code è possibile approfondire i KIT di montaggio e installazione degli elettrodomestici in tabella (compresi nei prezzi degli elettrodomestici stessi o acquistabili separatamente). Fantin non si assume responsabilità per montaggio e installazione di altri elettrodomestici. In tal caso, si consiglia di consultare il documento - qui scaricabile - con un installatore qualificato. Frame Kitchens è compatibile con l'installazione di elettrodomestici Miele che hanno dimensioni adatte a quanto indicato nel documento scaricabile dal QR code. Per questi, Fantin si rende disponibile a valutare la produzione di un kit di montaggio, una volta ricevuta la specifica scheda tecnica di installazione.

• Über den QR-Code können Sie mehr über die Montage- und Bausätze (die im Lieferumfang der Geräte enthalten oder separat erhältlich sind) für die in der Tabelle aufgeführten Haushaltsgeräte erfahren. Fantin übernimmt keine Haftung für die Montage und Installation anderer Haushaltsgeräte. In diesem Fall empfehlen wir Ihnen, die Beschreibung, die hier heruntergeladen werden kann, mit einem qualifizierten Installateur zu konsultieren.

Frame Kitchens ist mit der Installation von Geräten der Marke Miele kompatibel, deren Abmessungen mit den Angaben der Beschreibung entsprechen, die über den QR-Code heruntergeladen werden kann. Für diese Geräte kann die Firma Fantin die Herstellung eines Montagesatzes in Erwägung ziehen, sobald sie das entsprechende Datenblatt erhalten hat.



Bases / Basi / Basen

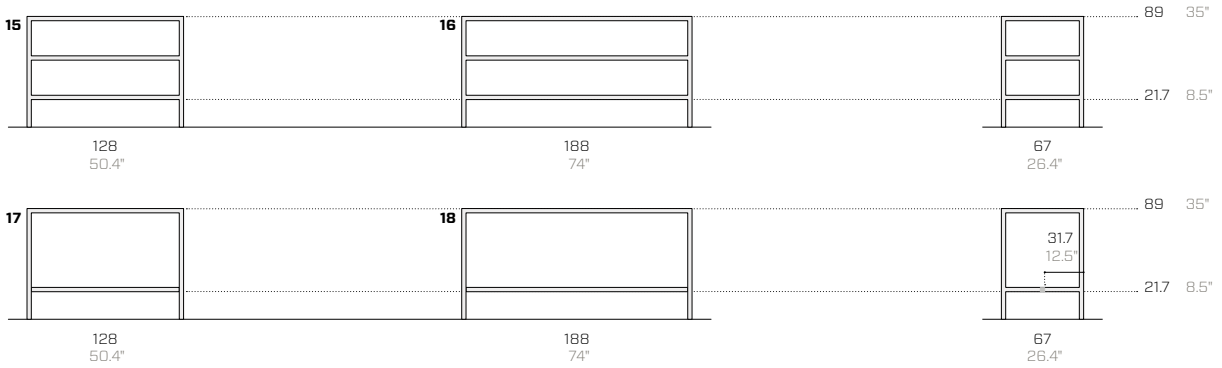

Top / Top / Arbeitsplatten



Accessories and details / Accessori e dettagli / Zubehör und Details

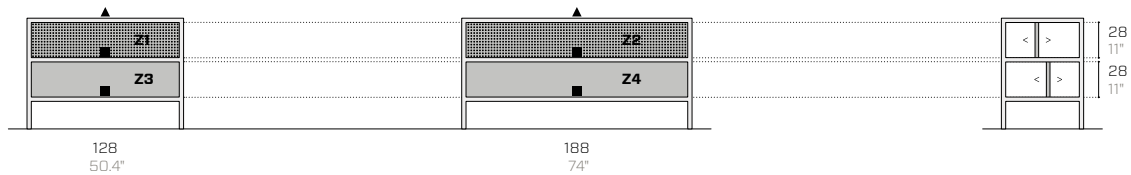

▲ Top (available in 4 versions)
Top (disponibile in 4 versioni)
Arbeitsplatte (in 4 Versionen erhältlich)

■ Lower shelves in metal (not replaceable)
Ripiani inferiori in metallo (non sostituibili)
Untere Regale aus Metall (nicht austauschbar)

Z. Full or perforated separator (freely positionable)
Separatore pieno o forato (liberamente posizionabile)
Voller oder perforierter Separator (frei positionierbar)

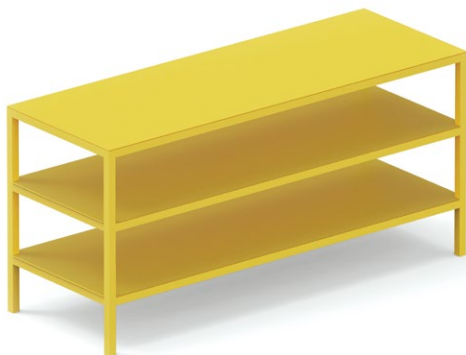

Product / Prodotto / Produkt

Packaging / Imballo / Verpackung

No.	Code	Dimensions (w-d-h)	Weight	Dimensions (w-d-h)	Weight	Vol pkg
Nr.	Codice	Dimensioni (l-p-h)	Peso	Dimensioni (l-p-h)	Peso	Vol. collo
Nr.	Code	Abmessungen (b-t-h)	Gewicht	Abmessungen (b-t-h)	Gewicht	Vol. Kollo
		cm	kg	cm	kg	mc

Bases / Basi / Basen

15	FR88	128 67 89	60	150 80 107	103	1.30
16	FR81	188 67 89	75	200 80 107	118	1.80
17	FR95	128 67 89	32	150 80 107	75	1.30
18	FR96	188 67 89	38	200 80 107	81	1.80

Metal top / Top in metallo / Arbeitsplatte aus Metall

Y1	FR88TOPS	128 67 0.3	16	132 71 10	20	0.10
Y2	FR81TOPS	188 67 0.3	23	192 71 10	28	0.20

Food-grade tops are found at the Finishes section / Top a uso alimentare indicati nella sezione Finiture / Die Lebensmittel-geeignete Arbeitsplatten sind im Abschnitt Finishes aufgeführt

Glass top / Top in vetro / Mit Arbeitsplatte in Glas

Y3	FRV01A	128 67 0.6		143 82 12	20	0.20
Y4	FRV05A	188 67 0.6		203 82 12	29	0.20

Satin finish stainless steel top / Top in acciaio inox satinato / Arbeitsplatte aus Edelstahl mit Satin-Finish

Y5	FRX201S	128 67 0.4	28	137 80 21	50	0.30
Y6	FRX209S	188 67 0.4	40	197 80 21	50	0.40

Vintage finish stainless steel top (Barazza) / Top in acciaio inox Vintage (Barazza) / Arbeitsplatte aus Edelstahl mit Vintage-Finish (Barazza)

Y7	FRB41V	128 67 0.4	28	137 80 21	50	0.30
Y8	FRB71V	188 67 0.4	40	197 80 21	50	0.40

Perforated separators / Separatori forati / Perforierte Separatoren

Z1	FRK05SF	128 28 4	4	132 32 5	9	0.10
Z2	FRK06SF	188 28 4	5	192 32 5	10	0.10

Full separators / Separatori pieni / Volle Separatoren

Z3	FRK07SC	128 28 4	5	132 32 5	9	0.10
Z4	FRK08SC	188 28 4	6	192 32 5	10	0.10

Wheel kit with colour-matching discs / Kit ruote con dischi in tinta / Radsatz mit farblich abgestimmten Scheiben

-	FRK31R8	8 3.5 10	2	20 10 10	3	0.10
-	FRK33R8	8 3.5 10	2	20 10 10	3	0.10

Useful measurements / Quote utili / Nützliche Maßen

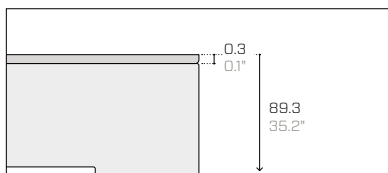

Metal top / Top in metallo / Arbeitsplatte aus Metall

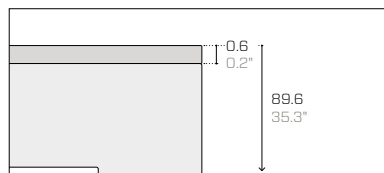

Glass top / Top in vetro / Arbeitsplatte aus Glas

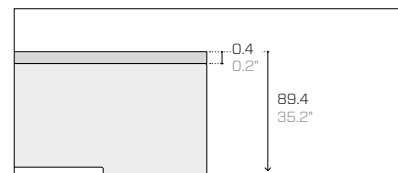

Stainless steel top / Top in inox / Arbeitsplatte aus Edelstahl

Metal essentials

	<p>01.18 Black (RAL 9005) Nero / Schwarz --- EM ▲</p>		<p>08.20 Rose quartz Rosa quarzo / Rosenquarz --- EM ▲■</p>		<p>15.19 Forest green (RAL 6007) Verde bosco / Waldgrün --- EM ▲●</p>
	<p>02.18 Anthracite (RAL 7021) Antracite / Anthrazit --- EM ▲●■</p>		<p>09.24 Terracotta (RAL 8004) Terracotta / Terrakotta --- EM ▲●■</p>		<p>16.24 Cement (RAL 7033) Cemento / Zement --- EM ▲●■</p>
	<p>03.18 Fantin grey Grigio Fantin / Fantin-Grau --- EM ▲●■</p>		<p>10.21 Flame red (RAL 3000) Rosso fuoco / Feuerrot --- EM ▲</p>		<p>17.24 Slate (RAL 7031) Ardesia / Schiefer --- EM ▲●■</p>
	<p>04.18 Light grey (RAL 7035) Grigio luce / Lichtgrau --- EM ▲●■</p>		<p>11.21 Melon yellow (RAL 1028) Giallo melone / Melonengelb --- EM ▲●</p>		<p>18.21 Dusty blue (RAL 5014) Azzurro polvere / Staubiges blau --- EM ▲■</p>
	<p>05.19 Cloud grey Grigio nuvola / Walkengrau --- EM ▲■</p>		<p>12.19 Zinc yellow (RAL 1018) Giallo zinco / Zinkgelb --- EM ▲■</p>		<p>19.18 Gentian blue (RAL 5010) Blu genziana / Enzianblau --- EM ▲●</p>
	<p>06.18 White (RAL 9016) Bianco / Weiß --- EM ▲■</p>		<p>13.21 Pastel green (RAL 6019) Verde pastello / Weißgrün --- EM ▲●■</p>		<p>20.19 Steel blue (RAL 5011) Blu acciaio / Stahlblau --- EM ▲</p>
	<p>07.21 Milk white (RAL 9001) Bianco latte / Milchweiß --- EM ▲●■</p>		<p>14.18 Sage green (RAL 6021) Verde salvia / Salbeigrün --- EM ▲●■</p>		<p>21.21 Coffee brown (RAL 8019) Marrone caffè / Kaffeebraun --- EM ▲■</p>

Metal design

Metallic



**61.24
Pale gold**
Oro chiaro / Hellgold

EM ▲ ■



**62.24
Copper**
Rame / Kupfer

EM ▲ ● ■



**47.21
Platinum**
Platino / Platin

EM ▲



**43.21
Bronze**
Bronzo / Bronze

EM ▲



**63.24
Graphite**
Grafite / Graphit

EM ▲ ●



**64.24
Silver green**
Verde argento / Silbergrün

EM ▲ ●



**65.24
Silver blue**
Blu argento / Silberblau

EM ▲ ●

Earth



**51.18
Sand**
Sabbia / Sand

EM ▲ ●

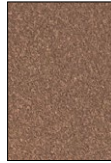

**57.21
Clay**
Creta / Lehm

EM ▲ ●



**52.18
Moss**
Muschio / Moos

EM ▲ ●



**66.24
Lichen**
Lichene / Flechte

EM ▲ ■



**67.24
Pink clay**
Argilla rosa / Rosa Ton

EM ▲ ● ■



**68.24
Sodalite**
Sodalite / Sodalith

EM ▲



**56.21
Ocean**
Oceano / Ozean

EM ▲

Surfaces / Superfici / Oberflächen

EM Embossed / Goffrato / Gaufriert

Use / Utilizzo / Verwenden

- ▲ Tops / Top / Arbeitsplatte
- Outdoor / Esterni / Außenbereich
- Food / Alimentare / Lebensmittel

Glass essentials

**G01.23**
Black (RAL 9005)

Nero / Schwarz

ET ▲ ■

**G08.23**
Rose quartz

Rosa quarzo / Rosenquarz

ET ▲ ■

**G15.23**
Forest green (RAL 6007)

Verde bosco / Waldgrün

ET ▲ ■

**G02.23**
Anthracite (RAL 7021)

Antracite / Anthrazit

ET ▲ ■

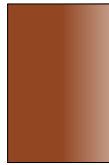
**G09.24**
Terracotta (RAL 8004)

Terracotta / Terrakotta

ET ▲ ■

**G16.24**
Cement (RAL 7033)

Cemento / Zement

ET ▲ ■

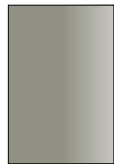
**G03.23**
Fantin grey

Grigio Fantin / Fantin-Grau

ET ▲ ■

**G10.23**
Flame red (RAL 3000)

Rosso fuoco / Feuerrot

ET ▲ ■

**G17.24**
Slate (RAL 7031)

Ardesia / Schiefer

ET ▲ ■

**G04.23**
Light grey (RAL 7035)

Grigio luce / Lichtgrau

ET ▲ ■

**G11.23**
Melon yellow (RAL 1028)

Giallo melone / Melonengelb

ET ▲ ■

**G18.23**
Dusty blue (RAL 5014)

Azzurro polvere / Staubiges blau

ET ▲ ■

**G05.23**
Cloud grey

Grigio nuvola / Wolkengrau

ET ▲ ■

**G12.23**
Zinc yellow (RAL 1018)

Giallo zinco / Zinkgelb

ET ▲ ■

**G19.23**
Gentian blue (RAL 5010)

Blu genziana / Enzianblau

ET ▲ ■

**G06.23**
White (RAL 9016)

Bianco / Weiß

ET ▲ ■

**G13.23**
Pastel green (RAL 6019)

Verde pastello / Weißgrün

ET ▲ ■

**G20.23**
Steel blue (RAL 5011)

Blu acciaio / Stahlblau

ET ▲ ■

**G07.23**
Milk white (RAL 9001)

Bianco latte / Milchweiß

ET ▲ ■

**G14.23**
Sage green (RAL 6021)

Verde salvia / Salbeigrün

ET ▲ ■

**G21.23**
Coffee brown (RAL 8019)

Marrone caffè / Kaffeebraun

ET ▲ ■

Glass design



G61.24
Pale gold
Oro chiaro / Hellgold

ET ▲ ■



G51.23
Sand
Sabbia / Sand

ET ▲ ■



G62.24
Copper
Rame / Kupfer

ET ▲ ■

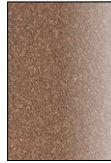

G57.23
Clay
Creta / Lehm

ET ▲ ■



G47.23
Platinum
Platino / Platin

ET ▲ ■



G52.23
Moss
Muschio / Moos

ET ▲ ■



G43.23
Bronze
Bronzo / Bronze

ET ▲ ■



G66.24
Lichen
Lichene / Flechte

ET ▲ ■



G63.24
Graphite
Grafite / Graphit

ET ▲ ■



G67.24
Pink clay
Argilla rosa / Rosa Ton

ET ▲ ■



G64.24
Silver green
Verde argento / Silbergrün

ET ▲ ■



G68.24
Sodalite
Sodalite / Sodalith

ET ▲ ■



G65.24
Silver blue
Blu argento / Silberblau

ET ▲ ■



G56.23
Ocean
Oceano / Ozean

ET ▲ ■

Surfaces / Superfici / Oberflächen

ET Etched / Acidato / Geätzt

Use / Utilizzo / Verwenden

- ▲ Tops / Top / Arbeitsplatte
- Outdoor / Esterni / Außenbereich
- Food / Alimentare / Lebensmittel

Stainless steel
Acciaio inox
Edelstahl CNS

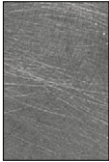

K1.18
Inox Vintage

Inox Vintage / Inox Vintage

HG ▲●■



K2.19
Inox Satin

Inox satinato / Inox satiniert

HG ▲●■

Surfaces / Superfici / Oberflächen

HG High Gloss / Lucido / Glänzend

Use / Utilizzo / Verwenden

- ▲ Tops / Top / Arbeitsplatte
- Outdoor / Esterni / Außenbereich
- Food / Alimentare / Lebensmittel

Technical information

Metal Non-toxic powder coating for interior use, with no heavy metals. Cured in an oven at 190 °C, following degreasing and phosphating. Guaranteed minimum thickness of 50 microns. Minimum resistance to salt spray of 200 hours (in accordance with the ASTM B117 standard). Some finishes are suitable for direct contact with food as required by Italian Law Decree D.M. 21/03/73 and subsequent updates. Requests for other RAL finishes can be considered. On some finishes, any partial discolouration following rubbing and/or abrasion has absolutely no effect on the technical, appearance/colour and chemical/physical characteristics of the product. This phenomenon tends to diminish over the useful life of the product and does not in any case present a health hazard to users.

Glass Extra-clear glass, with a thickness of 6 mm (0.24"), etched on the top, ground with a matt edge. Coated on the back with water-based paint in the 35 Fantin finishes.

AISI 304 stainless steel Kitchen top with a thickness of 4 mm (0.16") with Vintage (exclusive Barazza manual processing, making it quicker and easier to maintain) or satin finish.

Informazioni tecniche

Metallo Verniciatura per interni a polveri atossiche prive di metalli pesanti, con passaggio in forno a 190 °C, previo trattamento di sgrassaggio e fosfatazione. Spessore minimo garantito 50 micron, resistenza minima in nebbia salina pari a 200 ore (norma ASTM B117). Alcune finiture sono idonee al contatto diretto con alimenti come previsto dal decreto italiano D.M. 21/03/73 e successivi aggiornamenti. Altre finiture RAL valutabili su richiesta. Su alcune finiture, l'eventuale parziale cessione di colore in seguito a strofinamento e/o abrasione non influisce assolutamente sulle caratteristiche tecniche, di aspetto/colore, e chimico-fisiche del prodotto. Tale fenomeno tende a diminuire nel corso della vita utile del manufatto e non comporta in alcun caso pericoli per la salute degli utilizzatori.

Vetro Vetro extra-chiaro di spessore 6 mm (0.24"), acidato superiormente, molato con bordo filo-opaco. Retroverniciato con verniciatura all'acqua nelle 35 finiture Fantin.

Acciaio inox AISI 304 Piano cucina spessore 4 mm (0.16") con finitura Vintage (lavorazione manuale esclusiva Barazza, la cui manutenzione è più semplice e agevole) o satinata.

Technische Informationen

Metall Die Pulverbeschichtung der gift- und schwermetallfreien Pulverlacke für Innenbereiche erfolgt im Lackierofen bei 190 °C nach vorheriger Entfettung und Phosphatierung. Die garantierte Mindeststärke der Lackschicht beträgt 50 Mikron bei einer Mindestprüfungsdauer von 200 Stunden im Salznebel (ASTM-Norm B117). Einige Oberflächen sind für den direkten Kontakt mit Lebensmitteln geeignet, wie in der Verordnung vorgesehen Italienisch D.M. 21/03/73 und folgende Aktualisierungen. Auf Anfrage können andere RAL-Finishes in Betracht gezogen werden. Bei einigen Ausführungen hat eine teilweise Verfärbung durch Reiben und/oder Abrieb keine Auswirkungen auf die technischen, optischen/farblichen und chemisch-physikalischen Eigenschaften des Produkts. Dieses Phänomen nimmt im Laufe der Nutzungsdauer des Produkts tendenziell ab und stellt in keinem Fall eine Gefahr für die Gesundheit der Benutzer dar.

Glas Extra klares Glas, Stärke 6 mm (0.24"), geätzte Oberseite, geschliffen mit bündiger, matter Kante. Rückseitig beschichtet mit Lack auf Wasserbasis in den 35 Farbtönen von Fantin.

Edelstahl CNS AISI 304 Küchenarbeitsplatte Stärke 4 mm (0.16") mit Vintage-Finish (exklusive Handverarbeitung Barazza, die leicht und bequem zu pflegen ist) oder satiniert.

Kitchens and workbenches with a visible support structure and inset doors and drawers, distinguishing visual features of the minimal design scheme.

Frame made of 35 x 35 mm (1.38" x 1.38") square tubes. Concealed levelling feet, laterally adjustable.

Top made of AISI 304 stainless steel filler panel with a thickness of 4 mm (0.16") with satin or Vintage finish (with exclusive Barazza manual processing). Also available with integrated sinks and equipment channels.

Top made of extra-clear glass, with a thickness of 6 mm (0.24"), etched on the top, ground with a matt edge. Coated on the back with water-based paint in the 35 Fantin finishes.

Top (only for workbenches) made of metal with a thickness of 3 mm (0.12") and a bottom fibreboard filler panel.

Doors inset in the frame, made of a double layer of bent sheet metal. Door thickness: 20 mm (0.79"). Metal handles with a coating in a colour to match the doors. Soft-close dampening hinges. 95° door opening.

Drawers with fronts inset in the frame, made of a double layer of bent sheet metal. Drawer front thickness: 20 mm (0.79"). Metal handles with a coating in a colour to match the drawer fronts. Drawers with Hettich runners and built-in stabilization and soft-close systems. Capacity: 40 kg (88.18 lb).

Sides and bases inset in the frame, made of bent sheet metal; filled sides.

Inside shelves made of bent sheet metal.

Optional backboards inset in the frame, made of metal.

Optional hobs – electric induction and gas – from Barazza, Electrolux, Elica.

Optional appliances with custom installation kit, from AEG, Barazza, Electrolux, Falmec.

Optional accessories – stainless steel sinks, roll-up draining mat, taps. Shelves, open compartments, panelling.

The kitchens are ready assembled (except for the tops).

Cucine e banconi caratterizzati dal telaio portante in vista ed ante e cassetti in luce, caratteristiche estetiche dal design minimale.

Telaio in tubolare quadrato 35 x 35 mm (1.38" x 1.38"). Piedini livellatori nascosti, regolabili lateralmente.

Top in acciaio Inox AISI 304 di spessore 4 mm (0.16") con finitura satinata o Vintage (lavorazione manuale esclusiva Barazza). Disponibile anche con vasche e canali attrezzati integrati.

Top in vetro extra-chiaro di spessore 6 mm (0.24"), acidato superiormente, molato con bordo filo-opaco. Retroverniciato con verniciatura all'acqua nelle 35 finiture Fantin.

Top in metallo (solo per banconi) di spessore 3 mm (0.12") con tamponamento inferiore in fibre di legno.

Ante in luce al telaio, in doppia lamiera piegata. Spessore delle ante 20 mm (0.79"). Maniglie in metallo verniciate in tinta con le ante. Cerniere ammortizzate. Apertura ante di 95°.

Cassetti con frontali in luce al telaio spessore 20 mm (0.79"), in doppia lamiera piegata. Maniglie in metallo verniciate in tinta con i frontali dei cassetti. Cassetti con guide Hettich, sistemi di stabilizzazione e soft-close integrati con portata 40 kg (88.18 lb).

Fianchi e fondi in luce al telaio, in lamiera piegata; fianchi tamponati.

Ripiani interni in lamiera piegata.

Schiene opzionali in metallo in luce al telaio.

Piani cottura opzionali – a induzione e a gas – Barazza, Electrolux, Elica.

Elettrodomestici opzionali – con kit di installazione personalizzato – AEG, Barazza, Electrolux, Falmec.

Accessori opzionali – vasche in acciaio inox, griglia multiuso avvolgibile, rubinetti. Mensole, vani a giorno, boiserie.

Le cucine vengono fornite montate (top esclusi).

Küchen und Werkbänke mit sichtbarem Tragegestell und bündigen Türen und Schubladen, ästhetischen Eigenschaften eines Minimaldesigns werden.

Gestell aus Vierkantrrohr 35 x 35 mm (1.38" x 1.38"). Unsichtbare, seitlich einstellbare Füße.

Arbeitsplatte in massiver Edelstahl CNS AISI 304 in Stärke 4 mm (0.16") mit Satin- oder Vintage-Finish (exklusive Handverarbeitug Barazza). Auch mit integrierten Becken und vorgerüsteten Abflüssen erhältlich.

Arbeitsplatte aus extra klares Glas, Stärke 6 mm (0,24"), geätzte Oberseite, geschliffen mit bündiger, matter Kante. Rückseitig beschichtet mit Lack auf Wasserbasis in den 35 Farbtönen von Fantin.

Arbeitsplatte (nur für Werkbänke) aus 3 mm (0.12") starkem Metall mit unterer Holzfaserdämmung.

Türen aus Doppelfalz-Blech, bündig mit dem Gestell. Stärke der Türen 20 mm (0.79"). Pulverbeschichtete Metallgriffe gleichfarbig mit den Türen. Gedämpfte Scharniere. 95° Türöffnung.

Schubladen aus Doppelfalz-Blech, mit Fronten bündig mit dem Gestell. Schubladenfrontstärke: 20 mm (0.79"). Pulverbeschichtete Metallgriffe gleichfarbig mit den Schubladenfronten. Schubladen mit Führungsschienen Hettich mit Stabilisations- und Soft-Close-Systemen und mit einer Tragfähigkeit von 40 kg (88.18 lb).

Seiten und Basen aus Falzblech, bündig mit dem Gestell; bündig Seiten.

Innere Einlegeböden aus Falzblech.

Optionale Rückwände aus Metall, bündig mit dem Gestell.

Optionale Kochfelder – elektrische Induktion und Gas – von Barazza, Electrolux, Elica.

Optionales Haushaltsgeräte mit benutzerdefiniertes Bausatz, von AEG, Barazza, Electrolux, Falmec.

Optionales Zubehör – Becken aus Edelstahl, aufrollbare Mehrweckmatte, Wasserhähne, Regalbretter, offene Fächer, Wandverkleidung.

Die Küchen werden montiert geliefert (ohne Arbeitsplatten).

Disclaimer / Esclusione di responsabilità / Haftungsausschluss

Fantin Srl reserves the right to change the dimensions and features of the products contained in this technical data sheet at any time and without prior notice. The finishes illustrated are purely indicative as the accuracy tolerances of printing processes should be taken into account.

Fantin Srl si riserva la facoltà di modificare in qualsiasi momento e senza preavviso le dimensioni e l'esecuzione dei prodotti contenuti nella presente scheda tecnica. Le finiture riportate hanno valore indicativo in quanto soggette alle tolleranze dei processi di stampa.

Fantin Srl behält sich das Recht vor, die angegebenen Maße und Ausführungen der Produkte, welche dieses Produktblatt enthält, jederzeit ohne Vorankündigung zu ändern. Aufgrund drucktechnischer Abweichungen dienen die dargestellten Ausführungen nur der Illustration.

Fantin Srl

via San Vito, 43
33080 - Bannia
di Fiume Veneto (PN)
Italia

t +39 0434 959 133
f +39 0434 560 037
fantin@fantin.com
www.fantin.com



UNI EN ISO 9001