

Frame

Kitchens & workbenches

Salvatore Indriolo, 2018



archiproducts
DESIGN AWARDS
—
WINNER 2018



Bases / Basi / Basen

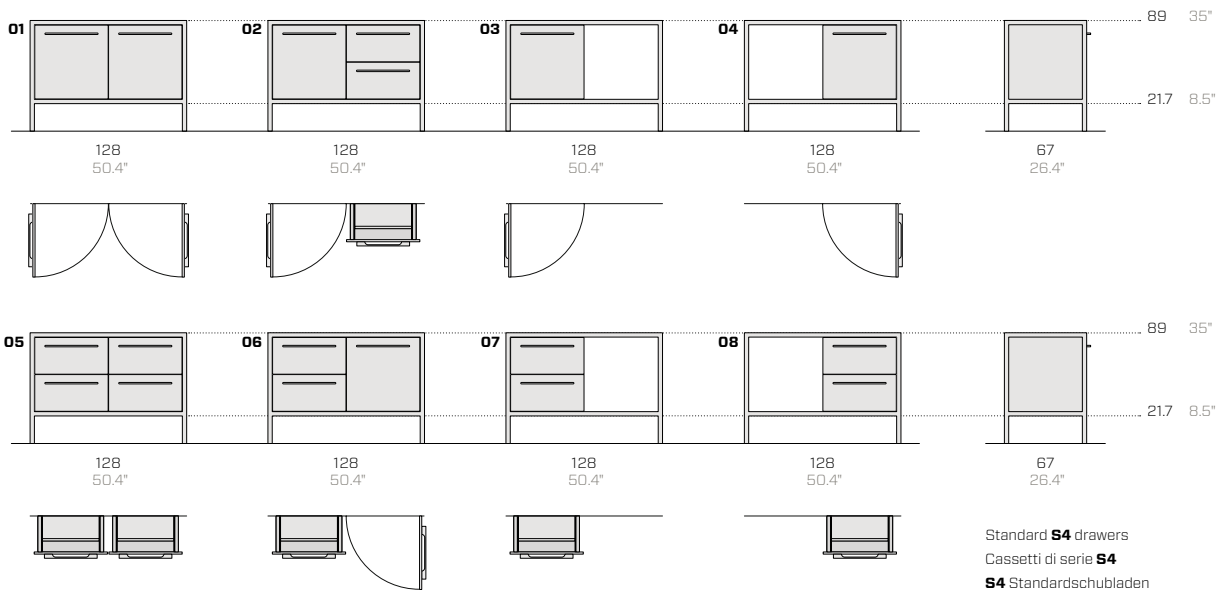

Tops (illustrated with a sink on the left) / Top (illustrati con vasca a sinistra) / Arbeitsplatten (abgebildet mit Becken auf der linken Seite)

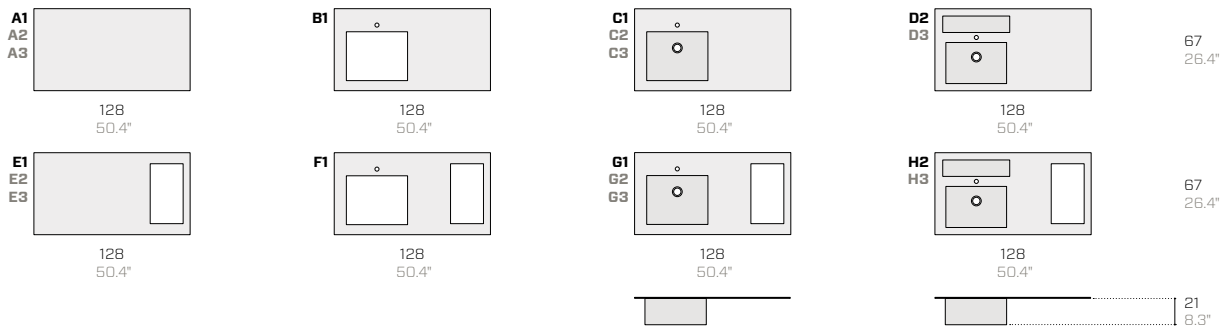

D, H with SST equipment channel / D, H con canale attrezzato in inox / D, H mit vorgerüstetem Abfluss aus Edelstahl

Useful measurements of the stainless steel top / Quote utili del top in inox / Nützliche Maßen der Edelstahlplatte

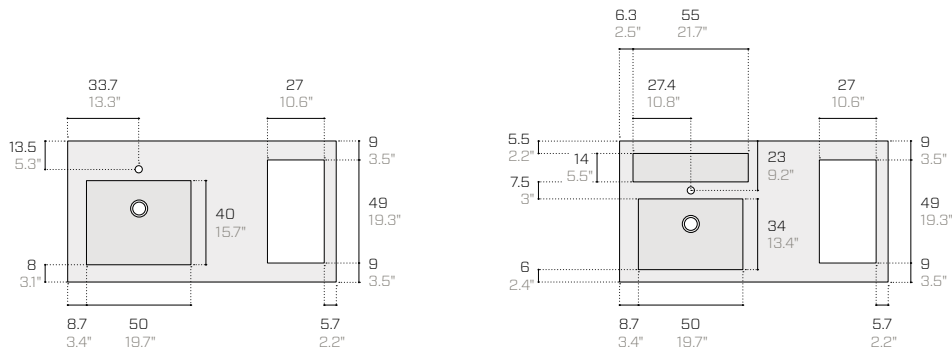

Product / Prodotto / Produkt

Packaging / Imballo / Verpackung

No.	Code	Dimensions (w-d-h)	Weight	Dimensions (w-d-h)	Weight	Vol pkg
N.	Codice	Dimensioni (l-p-h)	Peso	Dimensioni (l-p-h)	Peso	Vol. collo
Nr.	Code	Abmessungen (b-t-h)	Gewicht	Abmessungen (b-t-h)	Gewicht	Vol. Kollo
			cm	kg	cm	kg
			cm	kg	cm	mc

Bases / Basi / Basen

01	FR85	128 67 89	60	150 80 107	92	1.30
02	FR91D	128 67 89	70	150 80 107	102	1.30
03	FR84S	128 67 89	55	150 80 107	87	1.30
04	FR84D	128 67 89	55	150 80 107	87	1.30
05	FR93	128 67 89	60	150 80 107	112	1.30
06	FR91S	128 67 89	70	150 80 107	102	1.30
07	FR92S	128 67 89	65	150 80 107	97	1.30
08	FR92D	128 67 89	65	150 80 107	97	1.30

Top made of Fenix / Top in Fenix / Arbeitsplatte aus Fenix

A1	FRB21F	128 67 1.2	16	143 82 17	21	0.20
B1	FRB22F	128 67 1.2	15	143 82 17	20	0.20
C1	FRB25F	128 67 1.2	20	143 82 30	25	0.40
E1	FRB23F	128 67 1.2	15	143 82 17	20	0.20
F1	FRB24F	128 67 1.2	14	143 82 17	19	0.20
G1	FRB26F	128 67 1.2	20	143 82 30	25	0.40

Satin finish stainless steel top (Barazza) / Top in acciaio Inox satinato (Barazza) / Arbeitsplatte aus Edelstahl mit Satin-Finish (Barazza)

A2	FRB31S	128 67 0.4	27	137 80 21	37	0.30
C2	FRB35S	128 67 0.4	25	137 80 50	35	0.60
D2	FRB92S	128 67 0.4	27	137 80 50	37	0.60
E2	FRB33S	128 67 0.4	23	137 80 21	33	0.30
G2	FRB36S	128 67 0.4	22	137 80 50	32	0.60
H2	FRB93S	128 67 0.4	25	137 80 50	35	0.60

Vintage finish stainless steel top (Barazza) / Top in acciaio Inox Vintage (Barazza) / Arbeitsplatte aus Edelstahl mit Vintage-Finish (Barazza)

A3	FRB41V	128 67 0.4	27	137 80 21	37	0.30
C3	FRB45V	128 67 0.4	25	137 80 50	35	0.60
D3	FRB94V	128 67 0.4	27	137 80 50	37	0.60
E3	FRB43V	128 67 0.4	23	137 80 21	33	0.30
G3	FRB46V	128 67 0.4	22	137 80 50	32	0.60
H3	FRB95V	128 67 0.4	25	137 80 50	35	0.60

Upstand (stainless steel, satin and Vintage finish) / Alzatina (acciaio inox, satinato o Vintage) / Wischleiste (Edelstahl, satin- und Vintage-Finish)

-	FRB81S	128 0.4 4	2.5	137 2 10	3	0.10
-	FRB81V	128 0.4 4	2.5	137 2 10	3	0.10

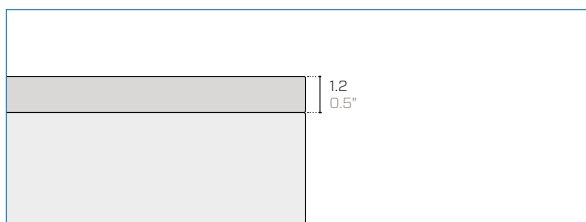

Fenix top / Top in Fenix / Arbeitsplatte aus Fenix

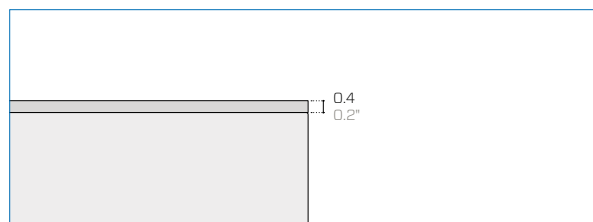

Stainless steel top / Top in acciaio inox / Arbeitsplatte aus Edelstahl

Bases / Basi / Basen

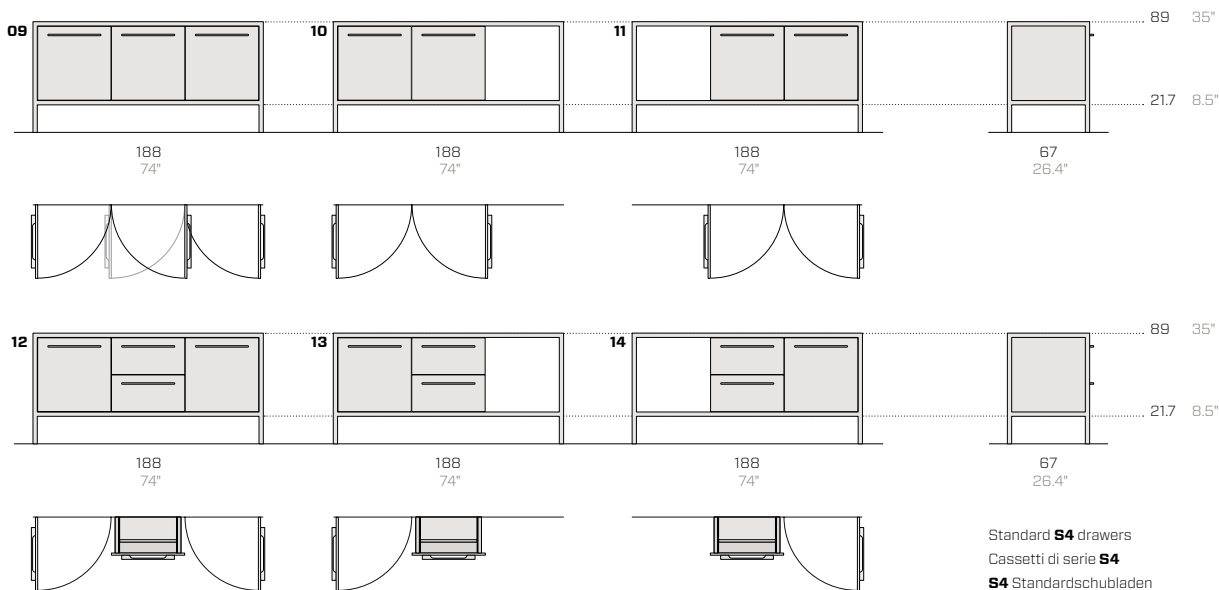

Tops (illustrated with a sink on the left) / Top (illustrati con vasca a sinistra) / Arbeitsplatten (abgebildet mit Becken auf der linken Seite)

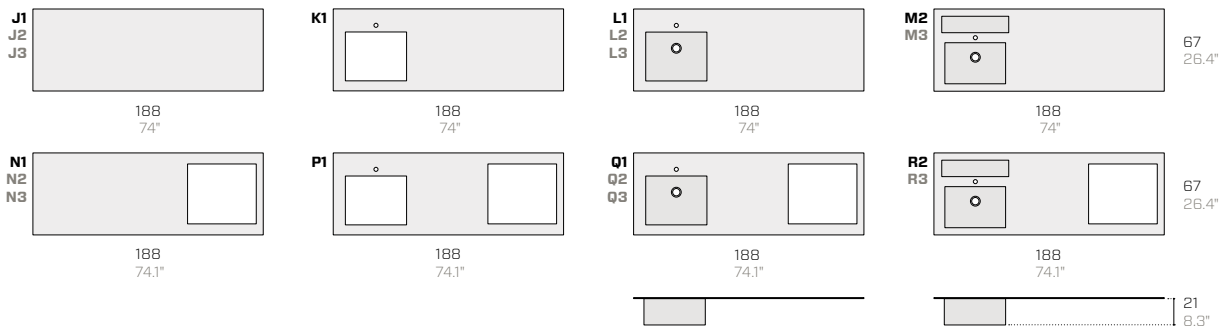

M, R with SST equipment channel / M, R con canale attrezzato in inox / M, R mit vorgerüstetem Abfluss aus Edelstahl

Useful measurements of the stainless steel top / Quote utili del top in inox / Nützliche Maßen der Edelstahlplatte

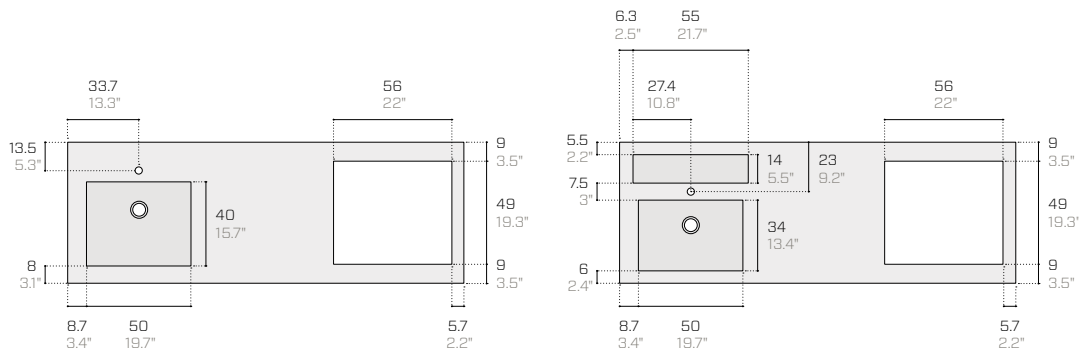

Product / Prodotto / Produkt

Packaging / Imballo / Verpackung

No.	Code	Dimensions (w-d-h)	Weight	Dimensions (w-d-h)	Weight	Vol pkg
N.	Codice	Dimensioni (l-p-h)	Peso	Dimensioni (l-p-h)	Peso	Vol. collo
Nr.	Code	Abmessungen (b-t-h)	Gewicht	Abmessungen (b-t-h)	Gewicht	Vol. Kollo

Bases / Basi / Basen

09	FR87	188 67 89	92	200 80 107	135	1.80
10	FR86S	188 67 89	87	200 80 107	130	1.80
11	FR86D	188 67 89	87	200 80 107	130	1.80
12	FR83	188 67 89	102	200 80 107	145	1.80
13	FR82S	188 67 89	97	200 80 107	140	1.80
14	FR82D	188 67 89	97	200 80 107	140	1.80

Top made of Fenix / Top in Fenix / Arbeitsplatte aus Fenix

J1	FRB51F	188 67 1.2	23	203 82 17	28	0.30
K1	FRB52F	188 67 1.2	22	203 82 17	27	0.30
L1	FRB55F	188 67 1.2	26	203 82 30	31	0.50
N1	FRB53F	188 67 1.2	22	203 82 17	27	0.30
P1	FRB54F	188 67 1.2	21	203 82 17	26	0.30
Q1	FRB56F	188 67 1.2	26	203 82 30	31	0.50

Satin finish stainless steel top (Barazza) / Top in acciaio Inox satinato (Barazza) / Arbeitsplatte aus Edelstahl mit Satin-Finish (Barazza)

J2	FRB61S	188 67 0.4	40	197 80 21	50	0.40
L2	FRB65S	188 67 0.4	38	197 80 50	48	0.80
M2	FRB96S	188 67 0.4	39	197 80 50	49	0.80
N2	FRB63S	188 67 0.4	31	197 80 21	41	0.40
Q2	FRB66S	188 67 0.4	30	197 80 50	40	0.80
R2	FRB97S	188 67 0.4	35	197 80 50	45	0.80

Vintage finish stainless steel top (Barazza) / Top in acciaio Inox Vintage (Barazza) / Arbeitsplatte aus Edelstahl mit Vintage-Finish (Barazza)

J3	FRB71V	188 67 0.4	40	197 80 21	50	0.40
L3	FRB75V	188 67 0.4	38	197 80 50	48	0.80
M3	FRB98V	188 67 0.4	39	197 80 50	49	0.80
N3	FRB73V	188 67 0.4	31	197 80 21	41	0.40
Q3	FRB76V	188 67 0.4	30	197 80 50	40	0.80
R3	FRB99V	188 67 0.4	35	197 80 50	45	0.80

Upstand (stainless steel, satin and vintage finish) / Alzatina (acciaio inox, satinato o Vintage) / Wischleiste (Edelstahl, satin- und Vintage-Finish)

-	FRB82S	188 0.4 4	3.5	197 2 10	4	0.10
-	FRB82V	188 0.4 4	3.5	197 2 10	4	0.10

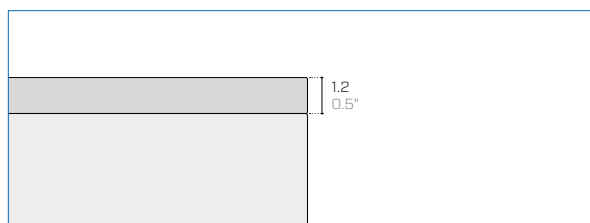

Fenix top / Top in Fenix / Arbeitsplatte aus Fenix

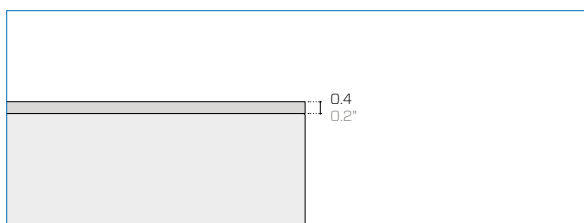

Stainless steel top / Top in acciaio inox / Arbeitsplatte aus Edelstahl

Drawer kits / Kit cassetti / Schubladen-Set

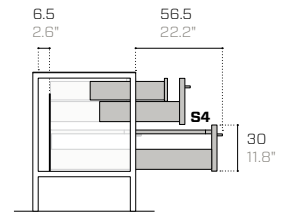
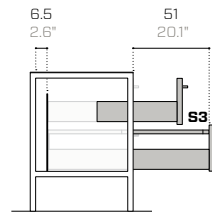
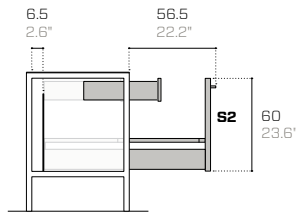
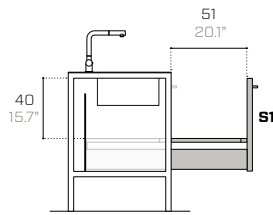

Kit 1 large drawer
Kit 1 cassettone
Set 1 Kommode



Kit 1 large drawer + 1 inner drawer
Kit 1 cassettone + cassetto interno
Set 1 Kommode + 1 Innenfach



Kit 2 drawers
Kit 2 cassetti
Set 2 Schubladen

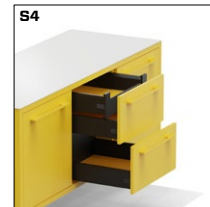

Kit 2 drawers + 1 inner drawer
Kit 2 cassetti + cassetto interno
Set 2 Schubladen + 1 Innenfach

Wheel kit with colour-matching discs / Kit ruote con dischi in tinta / Radsatz mit farblich abgestimmten Scheiben

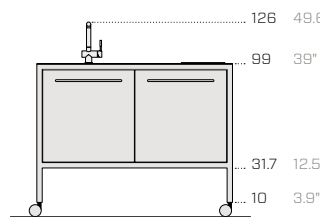

Kitchen height (with wheels)
Altezza cucina (con ruote)
Küchenhöhe (mit Rädern)

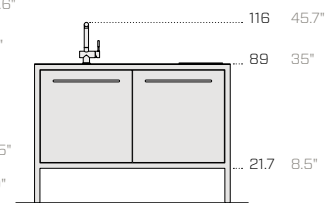

Kitchen height (without wheels)
Altezza cucina (senza ruote)
Küchenhöhe (ohne Rädern)

Product / Prodotto / Produkt

Packaging / Imballo / Verpackung

No.	Code	Dimensions (w-d-h)	Weight	Dimensions (w-d-h)	Weight	Vol pkg
N.	Codice	Dimensioni (l-p-h)	Peso	Dimensioni (l-p-h)	Peso	Vol. collo
Nr.	Code	Abmessungen (b-t-h)	Gewicht	Abmessungen (b-t-h)	Gewicht	Vol. Kollo
:	:	cm	kg	cm	kg	mc

Drawer kits (surcharge on the door price) / Kit cassetti (sovrapprezzo costo anta) / Schubladen-Set (Zuschlag auf den Türpreis)

S1	FRK21C1	60 55 60	13	63 58 63	14	-
S2	FRK20C2	60 55 60	18	63 58 63	19	-
S3	FRK22C2	60 55 60	15	63 58 63	16	-
S4	FRK23C3	60 55 60	20	63 58 63	21	-

Aluminum cutlery dividers / Divisori portaposate in alluminio / Besteckteiler aus aluminium

-	FRK09DP	48 8 5	1	50 10 6	1	-
---	---------	--------	---	---------	---	---

Waste separation systems / Kit di contenitori per raccolta differenziata / Abfalltrennsystem

-	FRK61DIF	44 29 22	3	50 10 6	4	-
-	FRK60DIF	46 30 30	2	50 10 6	3	-

Additional shelf / Ripiano aggiuntivo / Zusätzlicher Einlegeboden

-	FRK10R1	57 46 2	3	50 10 6	3	-
---	---------	---------	---	---------	---	---

Wheel kit with colour-matching discs / Kit ruote con dischi in tinta / Radsatz mit farblich abgestimmten Scheiben

T	FRK31R8	8 3.5 10	2	20 10 10	3	-
----------	---------	----------	---	----------	---	---

Other useful measurements / Altre quote utili / Andere nützliche Maßen

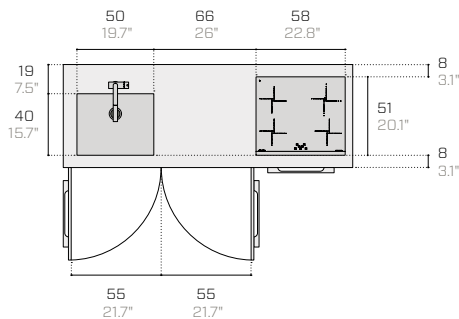
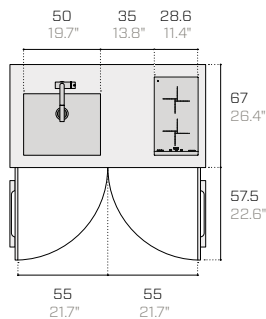
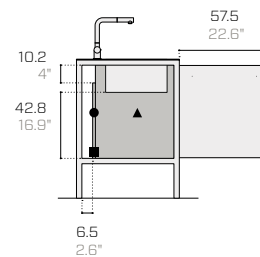
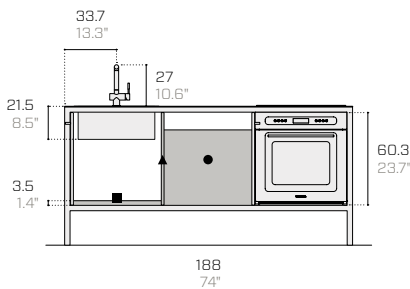
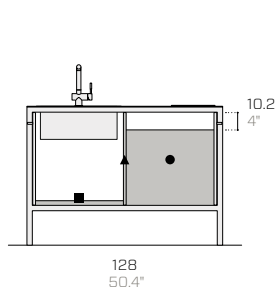

- Removable plinth H 3.5 or 8 cm
Zoccolo rimovibile H 3.5 o 8 cm
Entfernbarer Sockel H 3.5 oder 8 cm
- ▲ Removable divider
Divisore rimovibile
Entfernbares seitliches Trennelement
- Removable back panel
Schiena rimovibile
Entfernbare Rückwand

Shelf / Mensola / Regalbrett

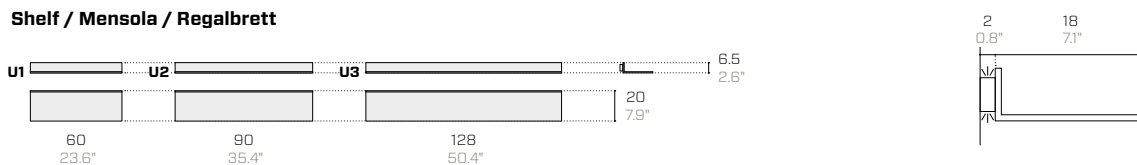

U3 compatible with 3000K LED bar / U3 compatibile con barra LED 3000K / U3 kompatibel mit 3000K LED Bar

Open compartment / Vano a giorno / Offenes Fach

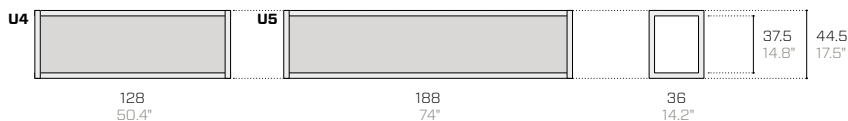
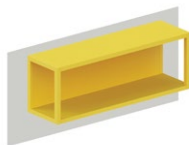

Wall panelling / Boiserie a parete / Wandverkleidungen

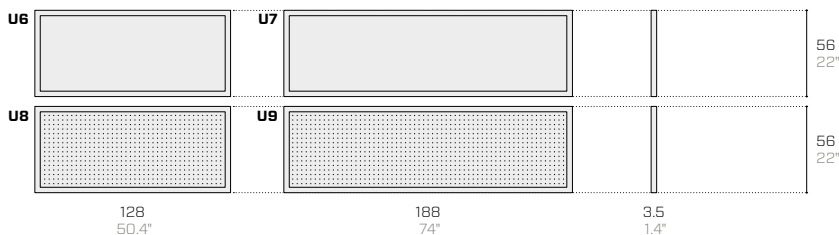

Wall panelling with shelf / Boiserie a parete con mensola / Wandverkleidungen mit Regal

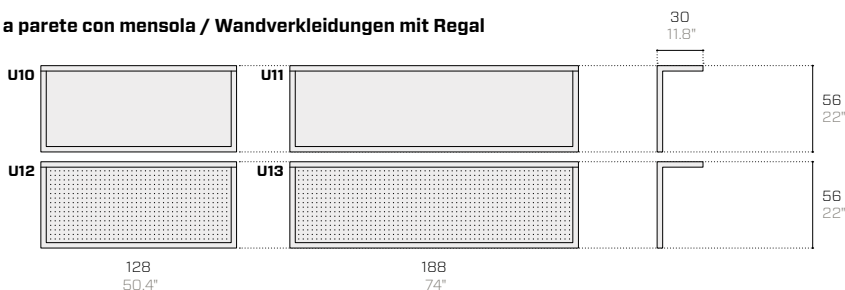

Items compatible with 3000K LED bar / Modelli compatibili con barra LED 3000K / Modelle kompatibel mit 3000K LED Bar

Useful measurements / Quote utili / Nützliche Maßen

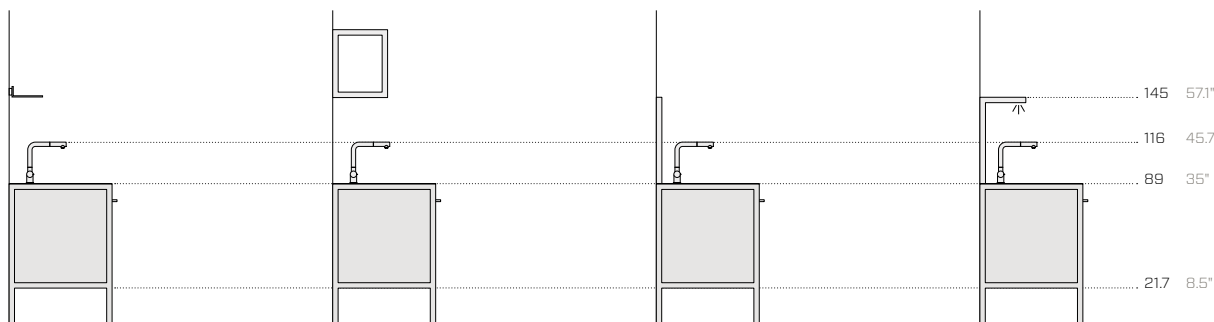

U1 / U2 / U3
Free scope for wall mounting
Fissaggio libero a parete
Freie Wandmontage

U4 / U5
Free scope for wall mounting
Fissaggio libero a parete
Freie Wandmontage

U6 / U7 / U8 / U9
Free scope for wall mounting
Fissaggio libero a parete
Freie Wandmontage

U10 / U11 / U12 / U13
Attachment to kitchen and wall
Fissaggio alla cucina e alla parete
Montage an Herd und Wand

Hobs / Piani cottura / Kochfelder

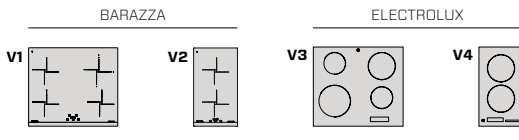

Electric induction hobs
 Piani cottura elettrici a induzione
 Elektrische Induktionskochfelder

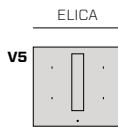

Electric induction hob with integrated filtering hood
 Piano cottura elettrico a induzione con cappa integrata filtrante
 Elektrisches Induktionskochfeld mit integrierter Filterhaube

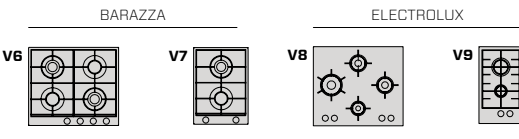

Gas hobs
 Piani cottura a gas
 Gaskochfelder

Integrated appliances / Elettrodomestici a incasso / Haushaltsgeräte zum Einbauen



Ovens
 Forni
 Öfen

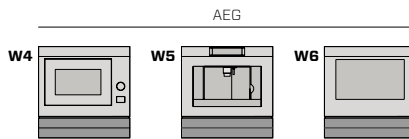

Microwave
 Microonde
 Microwelle

Coffee maker
 Macchina del caffè
 Kaffeemaschine

Wine cooler
 Cantinetta
 Weinkühlschrank

Integrated small drawer
 Cassettino integrato
 Integrierte Klein Schublade
 H 13 cm (5.1")

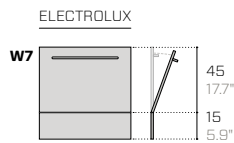

Dishwasher with Fantin door
 Lavastoviglie con anta Fantin
 Geschirrspüler mit Fantin Tür

- Integrated appliances require specific installation kits. Fantin does not provide fitting kits for other models of appliances and will accept no responsibility for the installation and assembly of other appliances not included in this datasheet. If you wish to install a different appliance, show your specialist fitter the document that can be downloaded by [clicking here](#).
- Gli elettrodomestici a incasso necessitano dei KIT specifici di installazione. Fantin non fornisce KIT di montaggio per altri modelli di elettrodomestici e non si assume responsabilità su installazione e montaggio di altri elettrodomestici non presenti in questa scheda. In tal caso, si suggerisce di verificare con il proprio installatore specializzato il documento scaricabile [cliccando qui](#).
- Die Einbaugeräte erfordern spezielle Bausätze für die Installation. Fantin liefert keine Bausätze für andere Modelle von Haushaltsgeräten und übernimmt keine Haftung für die Installation und Montage anderer Haushaltsgeräte, die nicht in der Preisliste enthalten sind. In diesem Fall wird empfohlen, die Broschüre - die Sie herunterladen können, indem Sie [hier klicken](#) - mit Ihrem Fachinstallateur zu konsultieren.

Product / Prodotto / Produkt

Packaging / Imballo / Verpackung

No.	Code	Brand code	Dimensions (w-d-h)	Weight	Dimensions (w-d-h)	Weight
N.	Codice	Codice marca	Dimensioni (l-p-h)	Peso	Dimensioni (l-p-h)	Peso
Nr.	Code	Herstellercode	Abmessungen (b-t-h)	Gewicht	Abmessungen (b-t-h)	Gewicht
			cm	kg	cm	kg

Electric induction hobs / Piani cottura elettrici a induzione / Elektrische Induktionskochfelder

V1	FRB05	1PIDG64	58	51	5.2	12	87	60	13	14
V2	FRB06	1PIDC30N	29	51	5.4	6	39	60	13	10
V3	FRE04	KTI6430E	59	52	6.5	12	80	60	15	14
V4	FRE02	EHH3320NOK	27	49	6.5	6	48	60	15	10

Aspirating induction hob (w/installation kit) / Piano induzione aspirante (con kit di installazione) / Induktionskochfeld mit Dunstabzug (mit Einbausatz)

V5	FRE37	PRF0167053	60	51.5	26	20	80	60	30	22
----	-------	------------	----	------	----	----	----	----	----	----

Kit for aspirating induction hob / Kit per piano induzione aspirante / Bausatz für Induktionskochfeld mit Dunstabzug

xV5	FRE37-KIT	-	-	-	-	-	-	-	-	-
-----	-----------	---	---	---	---	---	---	---	---	---

Gas hobs / Piani cottura a gas / Gaskochfelder

V6	FRE32	1PBF64	58	51	5.2	12	87	60	13	14
V7	FRE31	1PBF2	29	51	5.4	6	39	60	13	10
V8	FRE33	PQF645UOX	59	52	6.5	12	80	60	15	14
V9	FRE21	PQX320V	27	49	6.5	6	48	60	15	10

Integrated appliances (w/installation kit) / Elettrodomestici a incasso (con kit di installazione) / Einbaugeräte (mit Einbausatz)

W1	FRB02V	1FUNPV	60	61	60	35	64	64	68	39
W2	FRE03	FQ203IXEV	60	60	55	33	64	64	68	37
W3	FRE05	BEK455220M	60	60	55	33	64	64	68	37
W4	FRE11	MBE2658DEM	60	53	60	28	66	54	53	31
W5	FRE12	KKK884500M	60	53	60	28	66	54	53	31
W6	FRE13	KWK884520M	60	53	60	28	66	54	53	31
W7	FRE36	ESL2500RO	56	55	45	38	60	56	51	40

Kits for integrated appliances / Kit per elettrodomestici a incasso / Bausätze für Einbaugeräte

xW1	FRB02V-KIT	-	-	-	-	-	-	-	-	-
xW2	FRE03-KIT	-	-	-	-	-	-	-	-	-
xW3	FRE05-KIT	-	-	-	-	-	-	-	-	-
xW4	FRE11-KIT	-	-	-	-	-	-	-	-	-
xW5	FRE12-KIT	-	-	-	-	-	-	-	-	-
xW6	FRE13-KIT	-	-	-	-	-	-	-	-	-
xW7	FRE36-KIT	-	-	-	-	-	-	-	-	-

W4



W5



W6



Stainless steel accessories for tops / Accessori in inox per top / Zubehör aus Edelstahl für die Arbeitsplatten

BARAZZA

X1

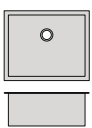

Satin undertop basin
Vasca satinata sottotop
Satinieretes Unterbaubecken

BARAZZA

X2

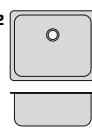

Satin overtop basin
Vasca satinata sopratop
Satinieretes Überbaubecken

BARAZZA

X3



Roll-up draining mat
Griglia multiuso avvolgibile
Aufrollbare Abtropfmatte

BARAZZA

X4
X5

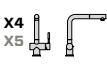

Steel taps
Rubinetti
Wasserhähne

X4: Chrome / Cromato / Chrom
X5: Black / Nero / Schwarz

BARAZZA

X6
X7

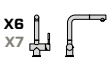

X6: Barazza Inox Satin
X7: Barazza Inox Vintage

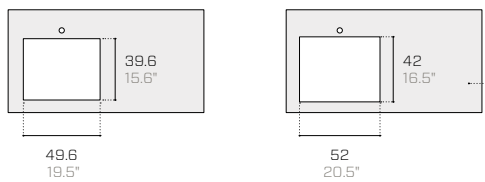

For tops with a thickness over 14 mm, check the slot for the overflow.
Per top con spessore superiore a 14 mm, verificare lo scanco per il troppopieno.
Für Arbeitsplatten mit einer Stärke von mehr als 14 mm, die Übereinstimmung mit dem Überlauf ist zu überprüfen wird.

Hole size for the X1 sink
Foratura top per vasca X1
Größe der Bohrungen für Beck X1

Hole size for the X2 sink
Foratura top per vasca X2
Größe der Bohrungen für Beck X2

SST accessories for the equipment channel / Accessori in inox per canale attrezzato / Zubehör aus Edelstahl für vorgerüsteten Abfluss

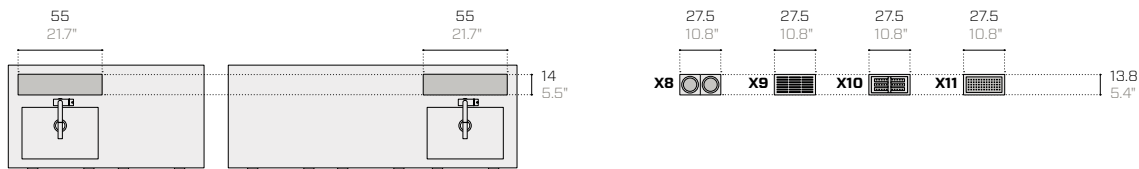

55 21.7" 55 21.7" 14 5.5"

27.5 10.8" 27.5 10.8" 27.5 10.8" 27.5 10.8" 13.8 5.4"

The equipment channel (H 20 cm) can hold a choice of 2 different items. Satin-finish AISI 304 stainless steel channel and accessories.

Il canale attrezzato (H 20 cm) contiene 2 accessori combinabili a scelta. Canale e accessori in acciaio inox AISI 304 satinato.

Der vorgerüstete Abfluss (H 20 cm) umfasst 2 Zubehörteile, die wahlweise kombiniert werden können. Abfluss und Zubehör aus satiniertem Edelstahl AISI 304.



X8
Bottle rack (H 17 cm; 2 pieces)
Portabottiglie (H 17 cm; 2 elementi)
Flaschenhalter (H 17 cm; 2 Elemente)



X9
Glass drainer (H 1.5 cm)
Scolabicchieri (H 1.5 cm)
Abtropfgitter (H 1.5 cm)



X10
Dish drainer (H 7 cm)
Scolapiatti (H 7 cm)
Abtropfgestell (H 7 cm)



X11
Sink (H 7 cm)
Vaschetta (H 7 cm)
Wanne (H 7 cm)

Product / Prodotto / Produkt

Packaging / Imballo / Verpackung

No.	Code	Brand code	Dimensions (w-d-h)	Weight	Dimensions (w-d-h)	Weight
Nr.	Codice	Codice marca	Dimensioni (l-p-h)	Peso	Dimensioni (l-p-h)	Peso
Nr.	Code	Herstellercode	Abmessungen (b-t-h)	Gewicht	Abmessungen (b-t-h)	Gewicht

Under-top basin in inox satin / Vasca sottotop in inox satinato / Unterbaubecken in Inox Satin

X1	FRB08S	-	53	43	22	5	60	50	27	8
-----------	--------	---	----	----	----	---	----	----	----	---

Over-top basin in inox satin / Vasca sopratop in inox satinato / Überbaubecken in Inox Satin

X2	FRB12S	-	54	44	21	4	60	50	26	7
-----------	--------	---	----	----	----	---	----	----	----	---

Roll-up draining mat / Griglia multiuso avvolgibile / Aufrollbare Abtropfmatte

X3	FRB11	-	47	45	1	1	50	8	8	1
-----------	-------	---	----	----	---	---	----	---	---	---

Steel taps / Rubinetti / Wasserhähne

X4	FRB10C	-	13	26	27	5	59	25	10	8
X5	FRB10N	-	13	26	27	5	59	25	10	8
X6	FRB10S	-	13	26	27	5	59	25	10	8
X7	FRB10V	-	13	26	27	5	59	25	10	8

SST accessories for the equipment channel / Accessori in inox per canale attrezzato / Zubehör aus Edelstahl für vorgerüsteten Abfluss

X8	FRB13S	-	27.5	13.8	17.0	-	-	-	-	-
X9	FRB14S	-	27.5	13.8	1.5	-	-	-	-	-
X10	FRB15S	-	27.5	13.8	7.0	-	-	-	-	-
X11	FRB16S	-	27.5	13.8	7.0	-	-	-	-	-

Back panel for freestanding kitchen / Schiena per cucina freestanding / Rückwand für freistehende Küche

-	FRK01S1	-	120	3	60	6	124	64	7	7
-	FRK02S2	-	180	3	60	9	184	64	7	10

Floor attachment cover kit / Kit di copertura allacciamenti a pavimento / Set für Abdeckung der Anschlüsse am Boden

-	FRK03A1	-	60	20	25	3	62	22	27	5
---	---------	---	----	----	----	---	----	----	----	---



Bases / Basi / Basen

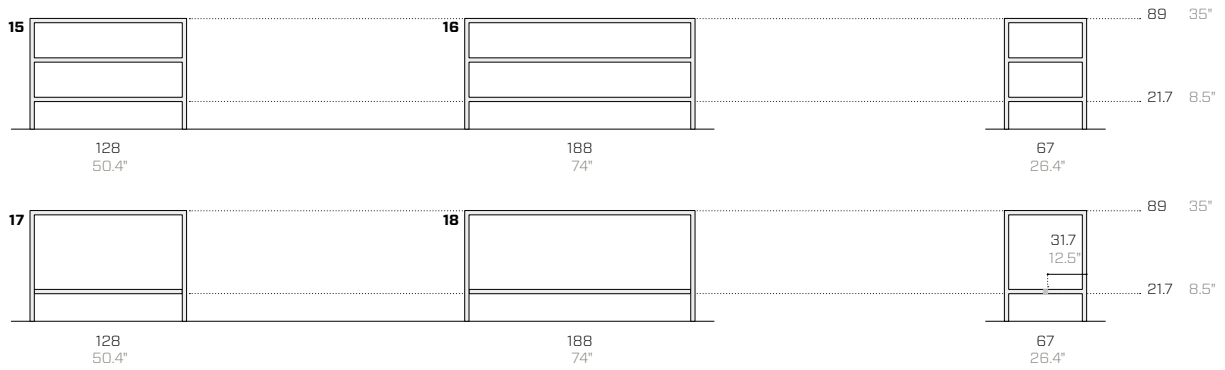

Top / Top / Arbeitsplatten



Accessories and details / Accessori e dettagli / Zubehör und Details

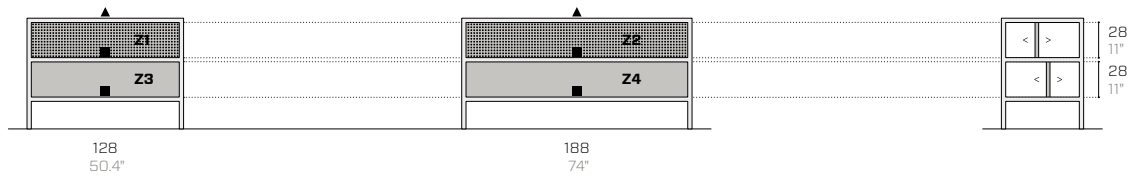

▲ Top (available in 4 versions)
Top (disponibile in 4 versioni)
Arbeitsplatte (in 4 Versionen erhältlich)

■ Lower shelves in metal (not replaceable)
Ripiani inferiori in metallo (non sostituibili)
Untere Regale aus Metall (nicht austauschbar)

Z. Full or perforated separator (freely positionable)
Separatore pieno o forato (liberamente posizionabile)
Voller oder perforierter Separator (frei positionierbar)



Product / Prodotto / Produkt					Packaging / Imballo / Verpackung					
No.	Code	Dimensions (w-d-h)			Weight	Dimensions (w-d-h)			Weight	Vol pkg
N.	Codice	Dimensioni (l-p-h)			Peso	Dimensioni (l-p-h)			Peso	Vol. collo
Nr.	Code	Abmessungen (b-t-h)			Gewicht	Abmessungen (b-t-h)			Gewicht	Vol. Kollo
			cm		kg		cm		kg	mc
Bases / Basi / Basen										
15	FR88	128	67	89	60	150	80	107	103	1.30
16	FR81	188	67	89	75	200	80	107	118	1.80
17	FR95	128	67	89	32	150	80	107	75	1.30
18	FR96	188	67	89	38	200	80	107	81	1.80
Metal top / Top in metallo / Arbeitsplatte aus Metall										
Y1	FR88TOPS	128	67	0.3	16	132	71	10	20	0.10
Y2	FR81TOPS	188	67	0.3	23	192	71	10	28	0.20
Food-grade tops are found at the Finishes section / Top a uso alimentare indicati nella sezione Finiture / Die Lebensmittel-geeignete Arbeitsplatten sind im Abschnitt Finishes aufgeführt										
Fenix top / Top in Fenix / Mit Arbeitsplatte in Fenix										
Y3	FRB21F	128	67	1.2	14	143	82	17	19	0.20
Y4	FRB51F	188	67	1.2	19	203	82	17	24	0.30
Satin finish stainless steel top (Barazza) / Top in acciaio Inox satinato (Barazza) / Arbeitsplatte aus Edelstahl mit Satin-Finish (Barazza)										
Y5	FRB31S	128	67	0.4	28	137	80	21	50	0.30
Y6	FRB61S	188	67	0.4	40	197	80	21	50	0.40
Vintage finish stainless steel top (Barazza) / Top in acciaio Inox Vintage (Barazza) / Arbeitsplatte aus Edelstahl mit Vintage-Finish (Barazza)										
Y7	FRB41V	128	67	0.4	28	137	80	21	50	0.30
Y8	FRB71V	188	67	0.4	40	197	80	21	50	0.40
Perforated separator / Separatore forato / Perforierter Separator										
Z1	FRK05SF	128	28	4	4	132	32	5	9	0.10
Z2	FRK06SF	188	28	4	5	192	32	5	10	0.10
Full separator / Separatore pieno / Voller Separator										
Z3	FRK07SC	128	28	4	5	132	32	5	9	0.10
Z4	FRK08SC	188	28	4	6	192	32	5	10	0.10
Wheel kit with colour-matching discs / Kit ruote con dischi in tinta / Radsatz mit farblich abgestimmten Scheiben										
-	FRK31R8	8	3.5	10	2	20	10	10	3	0.10

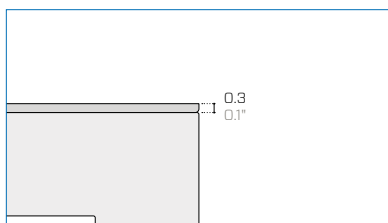

Metal top / Top in metallo / Arbeitsplatte aus Metall

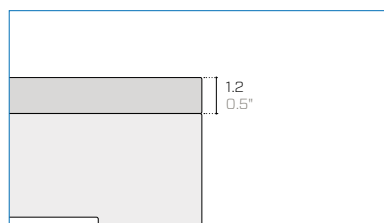

Fenix top / Top in Fenix / Arbeitsplatte aus Fenix

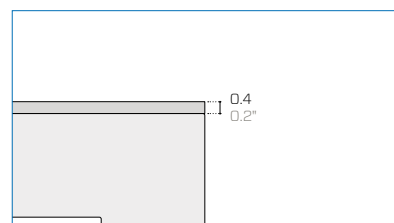

Stainless steel top / Top in inox / Arbeitsplatte aus Edelstahl

Metal essentials

	<p>01.18 Black (RAL 9005) Nero / Schwarz --- EM ▲ ■</p>		<p>08.20 Rose quartz Rosa quarzo / Rosenquarz --- EM ▲</p>		<p>15.19 Forest green (RAL 6007) Verde bosco / Waldgrün --- EM ▲ ●</p>
	<p>02.18 Anthracite (RAL 7021) Antracite / Anthrazit --- EM ▲ ● ■</p>		<p>09.18 Ruby red (RAL 3003) Rosso rubino / Rubinrot --- EM ▲</p>		<p>16.19 Turquoise blue (RAL 5018) Blu turchese / Türkisblau --- EM ▲</p>
	<p>03.18 Fantin grey Grigio Fantin / Fantin-Grau --- EM ▲ ■</p>		<p>10.21 Flame red (RAL 3000) Rosso fuoco / Feuerrot --- EM ▲ ●</p>		<p>17.18 Pastel blue (RAL 5024) Blu pastello / Pastellblau --- EM ▲</p>
	<p>04.18 Light grey (RAL 7035) Grigio luce / Lichtgrau --- EM ▲ ■</p>		<p>11.21 Melon yellow (RAL 1028) Giallo melone / Melonengelb --- EM ▲ ●</p>		<p>18.21 Dusty blue (RAL 5014) Azzurro polvere / Staubiges blau --- EM ▲ ●</p>
	<p>05.19 Cloud grey Grigio nuvola / Wolkengrau --- EM ▲ ■</p>		<p>12.19 Zinc yellow (RAL 1018) Giallo zinco / Zinkgelb --- EM ▲</p>		<p>19.18 Gentian blue (RAL 5010) Blu genziana / Enzianblau --- EM ▲ ●</p>
	<p>06.18 White (RAL 9016) Bianco / Weiß --- EM ▲ ■</p>		<p>13.21 Pastel green (RAL 6019) Verde pastello / Weißgrün --- EM ▲ ●</p>		<p>20.19 Steel blue (RAL 5011) Blu acciaio / Stahlblau --- EM ▲</p>
	<p>07.21 Milk white (RAL 9001) Bianco latte / Milchweiß --- EM ▲ ● ■</p>		<p>14.18 Sage green (RAL 6021) Verde salvia / Salbeigrün --- EM ▲ ●</p>		<p>21.21 Coffee brown (RAL 8019) Marrone caffè / Kaffeebraun --- EM ▲</p>

Metal design

Metallic



41.18
Gold
Oro / Gold

EM ▲



43.21
Bronze
Bronzo / Bronze

EM ▲



47.21
Platinum
Platino / Platin

EM ▲



46.21
Titanium
Titanio / Titan

EM ▲



45.21
Silver
Argento / Silber

EM ▲



44.18
Iron
Ferro / Eisen

EM ▲



42.19
Rust
Ruggine / Rost

EM ▲●

Earth



51.18
Sand
Sabbia / Sand

EM ▲●



57.21
Clay
Creta / Lehm

EM ▲●



52.18
Moss
Muschio / Moos

EM ▲●



53.18
Basalt
Basalto / Basalt

EM ▲●



54.18
Stone
Pietra / Stein

EM ▲●



55.18
Amethyst
Ametista / Amethyst

EM ▲



56.21
Ocean
Oceano / Ozean

EM ▲

Surfaces / Superfici / Oberflächen

EM Embossed / Goffrato / Gaufriert

Use / Utilizzo / Verwenden

- ▲ Tops / Top / Arbeitsplatte
- Outdoor / Esterni / Außenbereich
- Food / Alimentare / Lebensmittel

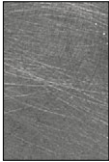
Inox Barazza**K1.18
Inox Vintage**

Inox Vintage / Inox Vintage

HG ▲●■**K2.19
Inox Satin**

Inox satinato / Inox satiniert

HG ▲●■

Surfaces / Superfici / Oberflächen**HG** High Gloss / Lucido / Glänzend

Use / Utilizzo / Verwenden

- ▲ Tops / Top / Arbeitsplatte
- Outdoor / Esterni / Außenbereich
- Food / Alimentare / Lebensmittel

Fenix NTM™

Best match available
Abbinamento suggerito
Paarungsvorschlag

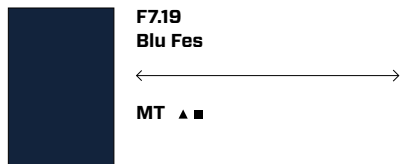
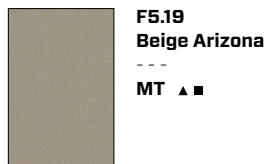
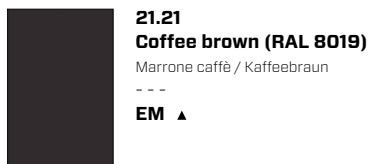
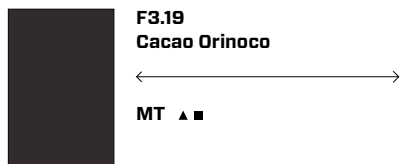
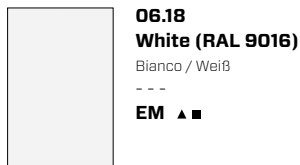
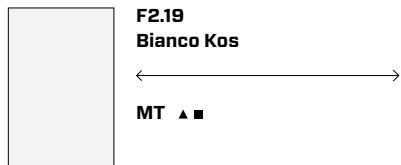
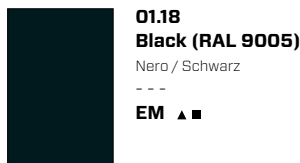
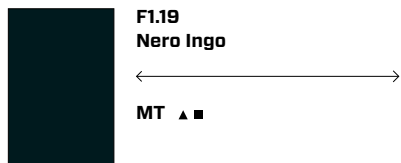

The tops in Fenix NTM™ can be matched with all Fantin finishes. The correspondences in this page represent the best match available and are not intended as perfect colour equivalences.

I top in Fenix NTM™ sono abbinabili a tutte le finiture Fantin. Le corrispondenze di questa pagina sono indicative e non si intendono come perfette equivalenze di colore.

Die Platten in Fenix NTM™ können mit allen Fantin-Oberflächen abgestimmt werden. Die Entsprechungen auf dieser Seite stellen die beste verfügbare Übereinstimmung dar und sind nicht als perfekte Farbäquivalenzen gedacht.

Surfaces / Superfici / Oberflächen

EM Embossed / Goffrato / Gaufriert
MT Matt / Opaco / Matt

Use / Utilizzo / Verwenden

- ▲ Tops / Top / Arbeitsplatte
- Food / Alimentare / Lebensmittel

Technical information

Metal Non-toxic powder coating for interior use, with no heavy metals. Cured in an oven at 190°C, following degreasing and phosphating. Guaranteed minimum thickness of 50 microns. Minimum resistance to salt spray of 200 hours (in accordance with the ASTM B117 standard). Some finishes are suitable for direct contact with food as required by Italian Law Decree D.M. 21/03/73 and subsequent updates. Requests for other RAL finishes can be considered.

AISI 304 stainless steel Kitchen top with a thickness of 4 mm (0.16") with Vintage (exclusive Barazza manual processing, making it quicker and easier to maintain) or satin finish.

Fenix Top and stove tops in 12 mm (0.47") Fenix NTM™ thermolaminate. Super matt, smudgeproof and restorable, gives the surface a warm aesthetic and is soft to the touch. Fenix NTM™ finishes are paired with the Fantin Ultra-matt (Metal Design) collection in the price list, in order to create monochrome products.

Informazioni tecniche

Metallo Verniciatura per interni a polveri atossiche prive di metalli pesanti, con passaggio in forno a 190 °C, previo trattamento di sgrassaggio e fosfatazione. Spessore minimo garantito 50 micron, resistenza minima in nebbia salina pari a 200 ore (norma ASTM B117). Alcune finiture sono idonee al contatto diretto con alimenti come previsto dal decreto italiano D.M. 21/03/73 e successivi aggiornamenti. Altre finiture RAL valutabili su richiesta.

Acciaio Inox AISI 304 Piano cucina spessore 4 mm (0.16") con finitura Vintage (lavorazione manuale esclusiva Barazza, la cui manutenzione è più semplice e agevole) o satinata.

Fenix Top e piani cucina in termolaminato Fenix NTM™ di spessore 12 mm (0.47"). Super opaco, antimpronta e ripristinabile, dona alla superficie un'estetica calda e morbida al tatto. Le finiture Fenix NTM™ a listino sono corrispondenti alla collezione Fantin Ultra-matt (Metal Design), al fine di creare prodotti monocromatici.

Technische Informationen

Metall Die Pulverbeschichtung der gift- und schwermetalldfreien Pulverlacke für Innenbereiche erfolgt im Lackierofen bei 190 °C nach vorheriger Entfettung und Phosphatierung. Die garantierte Mindeststärke der Lackschicht beträgt 50 Mikron bei einer Mindestprüfungsdauer von 200 Stunden im Salznebel (ASTM-Norm B117). Einige Oberflächen sind für den direkten Kontakt mit Lebensmitteln geeignet, wie in der Verordnung vorgesehen Italienisch D.M. 21/03/73 und folgende Aktualisierungen. Auf Anfrage können andere RAL-Finishes in Betracht gezogen werden.

Edelstahl CNS AISI 304 Küchenarbeitsplatte Stärke 4 mm (0.16") mit Vintage-Finish (exklusive Handverarbeitung Barazza, die leicht und bequem zu pflegen ist) oder satiniert.

Fenix Abdeckung und Küchenarbeitsplatten aus Thermolaminat Fenix NTM™ in der Stärke 12 mm (0.47"). Die superopake Oberfläche mit Anti-Fingerprint-Schutz ist wiederherstellbar, hat eine warme Optik und eine weiche Haptik. Die Finishes Fenix NTM™ der Liste entsprechen denen der Kollektion Fantin Ultra-matt (Metal Design), sodass unifarbene Produkte entstehen.

Kitchens and workbenches from the Frame range, with a visible support structure and inset doors and drawers that are distinguishing visual features of the minimal design scheme.

Frame made of 35 x 35 mm (1.38" x 1.38") square tubes. Concealed adjustable feet.

Top made of Fenix with a thickness of 12 mm (0.47") or AISI 304 stainless steel filler panel with a thickness of 4 mm (0.16") with satin or Vintage finish (with exclusive Barazza manual processing). Also available with integrated sinks and equipment channels.

Top (only for workbenches) made of metal with a thickness of 3 mm (0.12") and a bottom fibreboard filler panel.

Doors inset in the frame, made of a double layer of bent sheet metal. Door thickness: 20 mm (0.79"). Metal handles with a coating in a colour to match the doors. Soft-close dampening hinges. 95° door opening.

Drawers with fronts inset in the frame, made of a double layer of bent sheet metal. Drawer front thickness: 20 mm (0.79"). Metal handles with a coating in a colour to match the drawer fronts. Drawers with Hettich runners and built-in stabilization and soft-close systems. Capacity: 40 kg (88.18 lb).

Sides and bases inset in the frame, made of bent sheet metal; filled sides.

Inside shelves made of bent sheet metal.

Optional backboards inset in the frame, made of metal.

Optional hobs – electric induction and gas – from Barazza, Electrolux, Elica.

Optional appliances with custom installation kit, from AEG, Barazza, Electrolux.

Optional accessories – stainless steel sinks, roll-up draining mat, taps – from Barazza. Shelves, open compartments, panelling.

The kitchens are ready assembled (except for the tops).

Cucine e banconi del programma Frame, caratterizzato dal telaio portante in vista ed ante e cassetti in luce, che diventano caratteristiche estetiche dal design minimale.

Telaio in tubolare quadrato 35 x 35 mm (1.38" x 1.38"). Piedini invisibili regolabili.

Top in Fenix di spessore 12 mm (0.47") o in acciaio Inox AISI 304 di spessore 4 mm (0.16") con finitura satinata o Vintage (lavorazione manuale esclusiva Barazza). Disponibile anche con vasche e canali attrezzati integrati.

Top in metallo (solo per banconi) di spessore 3 mm (0.12") con tamponamento inferiore in fibre di legno.

Ante in luce al telaio, in doppia lamiera piegata. Spessore delle ante 20 mm (0.79"). Maniglie in metallo verniciate in tinta con le ante. Cerniere ammortizzate. Apertura ante di 95°.

Cassetti con frontali in luce al telaio spessore 20 mm (0.79"), in doppia lamiera piegata. Maniglie in metallo verniciate in tinta con i frontali dei cassetti. Cassetti con guide Hettich, sistemi di stabilizzazione e soft-close integrati con portata 40 kg (88.18 lb).

Fianchi e fondi in luce al telaio, in lamiera piegata; fianchi tamponati.

Ripiani interni in lamiera piegata.

Schiene opzionali in metallo in luce al telaio.

Piani cottura opzionali – a induzione e a gas – Barazza, Electrolux, Elica.

Elettrodomestici opzionali – con kit di installazione personalizzato – AEG, Barazza, Electrolux.

Accessori opzionali – vasche in acciaio inox, griglia multiuso avvolgibile, rubinetti – Barazza. Mensole, vani a giorno, boiserie.

Le cucine vengono fornite montate (top esclusi).

Küchen und Werkbänke aus der Frame-Linie mit sichtbarem Tragegestell und bündigen Türen und Schubläden, die zu den ästhetischen Eigenschaften eines Minimaldesigns werden.

Gestell aus Vierkantrohr 35 x 35 mm (1.38" x 1.38"). Unsichtbare, einstellbare Füße.

Arbeitsplatte in Fenix, Stärke 12 mm (0.47") oder massiver Edelstahl CNS AISI 304 in Stärke 4 mm (0.16") mit Satin- oder Vintage-Finish (exklusive Handverarbeitung Barazza). Auch mit integrierten Becken und vorgefertigten Abflüssen erhältlich.

Arbeitsplatte (nur für Werkbänke) aus 3 mm (0.12") starkem Metall mit unterer Holzfaserdämmung.

Türen aus Doppelfalz-Blech, bündig mit dem Gestell. Stärke der Türen 20 mm (0.79"). Pulverbeschichtete Metallgriffe gleichfarbig mit den Türen. Gedämpfte Scharniere. 95° Türöffnung.

Schubläden aus Doppelfalz-Blech, mit Fronten bündig mit dem Gestell. Schubladenfrontstärke: 20 mm (0.79"). Pulverbeschichtete Metallgriffe gleichfarbig mit den Schubladenfronten. Schubladen mit Führungsschienen Hettich mit Stabilisations- und Soft-Close-Systemen und mit einer Tragfähigkeit von 40 kg (88.18 lb).

Seiten und Basen aus Falzblech, bündig mit dem Gestell; bündig Seiten.

Innere Einlegeböden aus Falzblech.

Optionale Rückwände aus Metall, bündig mit dem Gestell.

Optionale Kochfelder – elektrische Induktion und Gas – von Barazza, Electrolux, Elica.

Optionales Haushaltsgeräte mit benutzerdefiniertes Bausatz, von AEG, Barazza, Electrolux.

Optionales Zubehör – Becken aus Edelstahl, aufrollbare Mehrzweckmatte, Wasserhähne – von Barazza. Regalbretter, offene Fächer, Wandverkleidung.

Die Küchen werden montiert geliefert (ohne Arbeitsplatten).

Disclaimer / Esclusione di responsabilità / Haftungsausschluss

Fantin Srl reserves the right to change the dimensions and features of the products contained in this technical data sheet at any time and without prior notice. The finishes illustrated are purely indicative as the accuracy tolerances of printing processes should be taken into account.

Fantin Srl si riserva la facoltà di modificare in qualsiasi momento e senza preavviso le dimensioni e l'esecuzione dei prodotti contenuti nella presente scheda tecnica. Le finiture riportate hanno valore indicativo in quanto soggette alle tolleranze dei processi di stampa.

Fantin Srl behält sich das Recht vor, die angegebenen Maße und Ausführungen der Produkte, welche dieses Produktblatt enthält, jederzeit ohne Vorankündigung zu ändern. Aufgrund drucktechnischer Abweichungen dienen die dargestellten Ausführungen nur der Illustration.

Fantin Srl

via San Vito, 43
33080 - Bannia
di Fiume Veneto (PN)
Italia

t +39 0434 959 133
f +39 0434 560 037
fantin@fantin.com
www.fantin.com



UNI EN ISO 9001