

- INSTRUCTION MANUAL -

SILHOUETTE SOFA

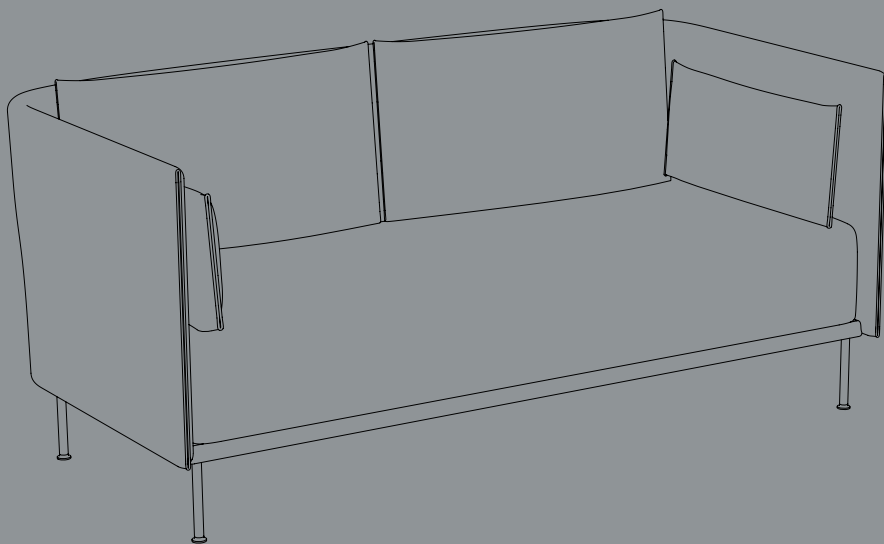

DESIGN BY GAMFRATESI

HAY

- PARTS -

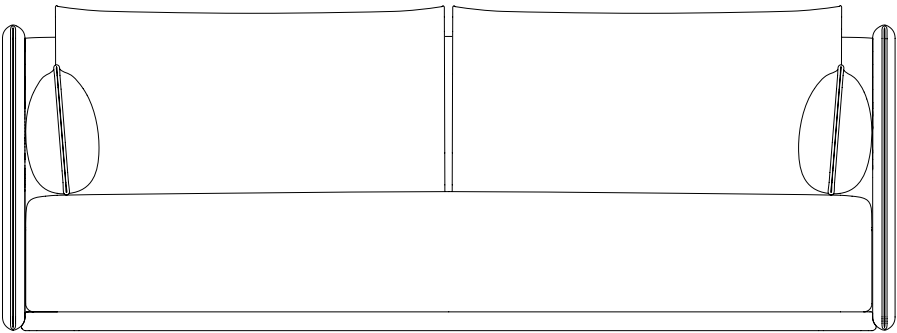

A Sofa x1

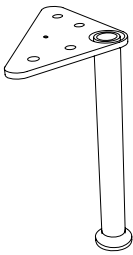

B Back leg x2

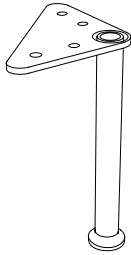

C Front leg x2

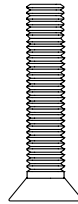

C Screw x16



D Allen key x1

1.

Turn the sofa 90° facing downwards (2 persons recommended).

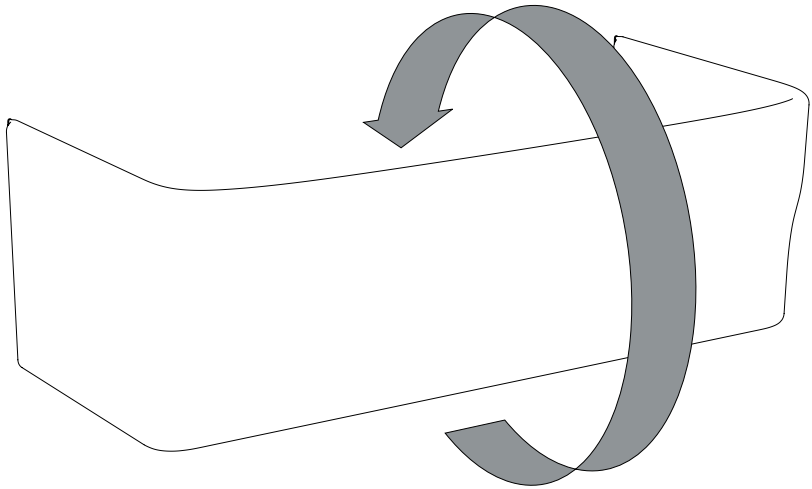

2.

Fasten the back legs to the sofa. Look for the back leg indicator (a small hole on the base) to identify the back legs, part **B**. Insert the **D** parts through the **B** part and into the **A** part as indicated. Tighten the screws with the Allen key.

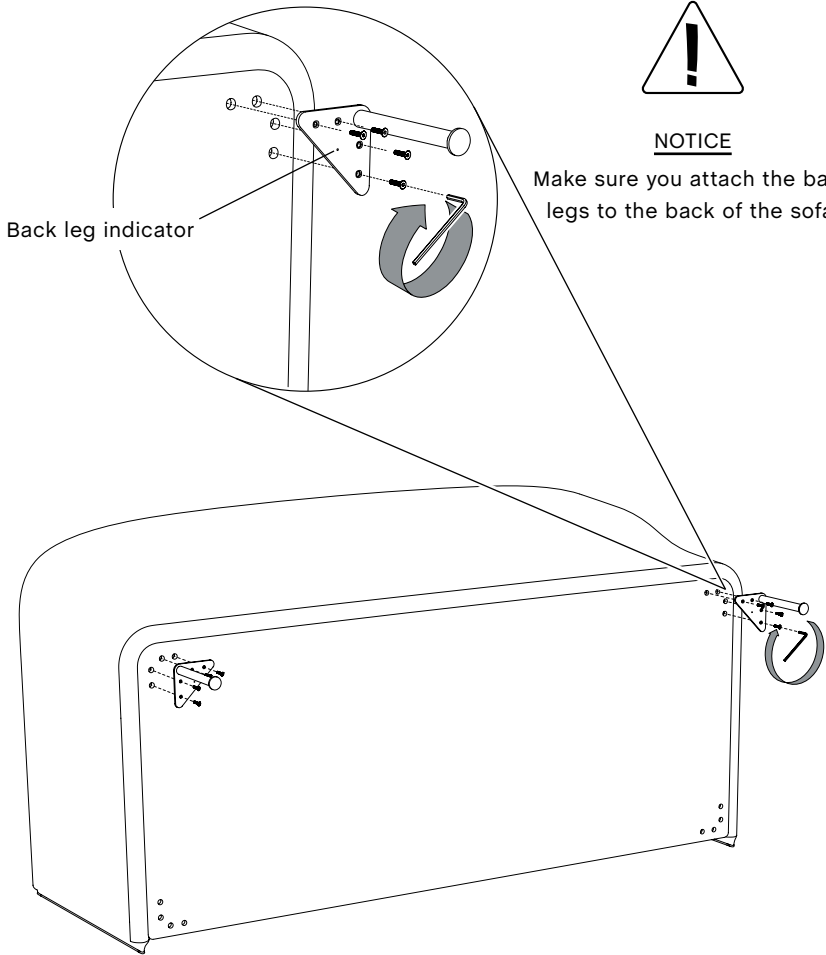

3.

Fasten the front legs to the sofa. Insert the **D** parts through the **C** part and into the **A** part as indicated. Tighten the screws with the Allen key. We recommend that the screws for front and back legs are retightened after one month of use and whenever needed.

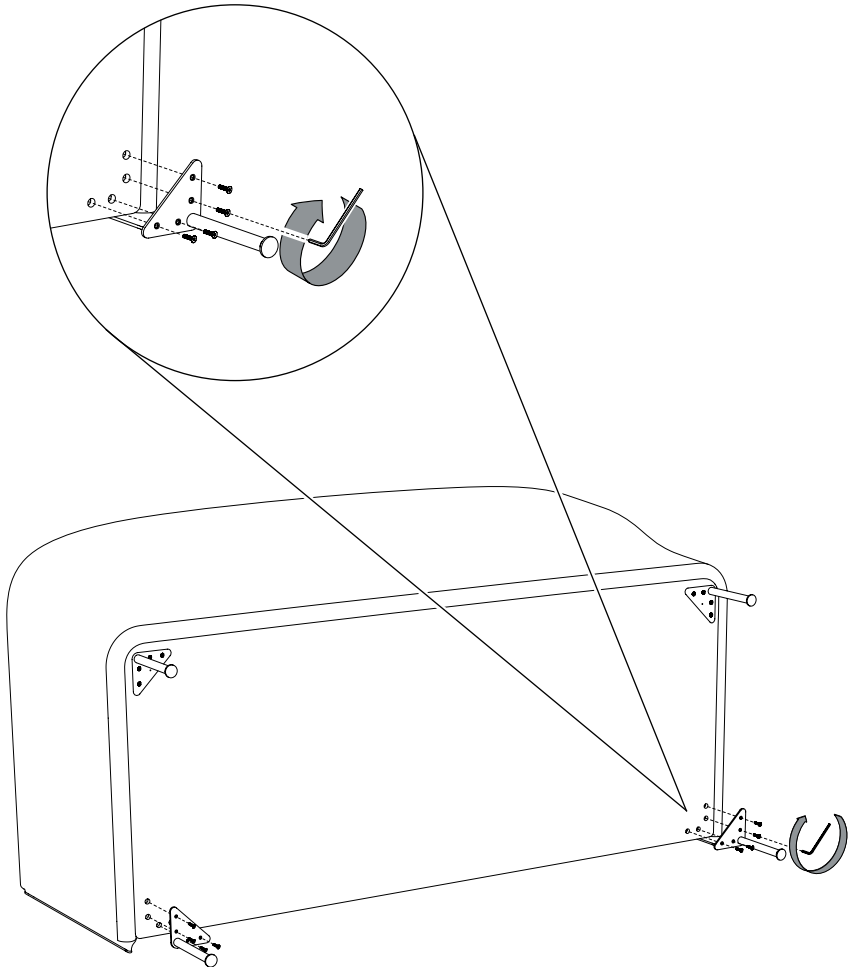

4.

Turn the sofa back into standing position (using a minimum of two people). To avoid damaging the legs, lift the sofa and turn it upright before putting it back down onto the floor. Make sure all screws are completely tightened.

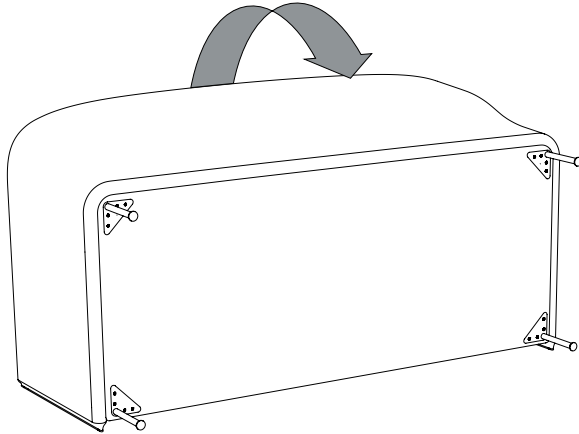

5.

Place cushions on the sofa.

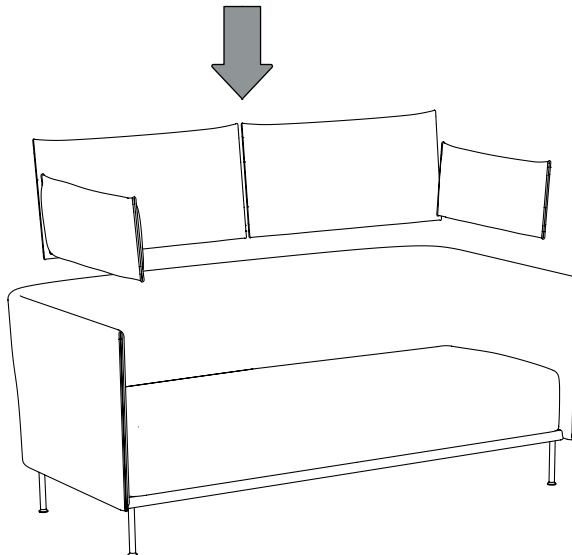

6.

Over time, your sofa will need some attention to ensure that the cushions are plump and the seat cushion keeps its shape. Straighten out any creases and lumps in the seat cushion with your hands.

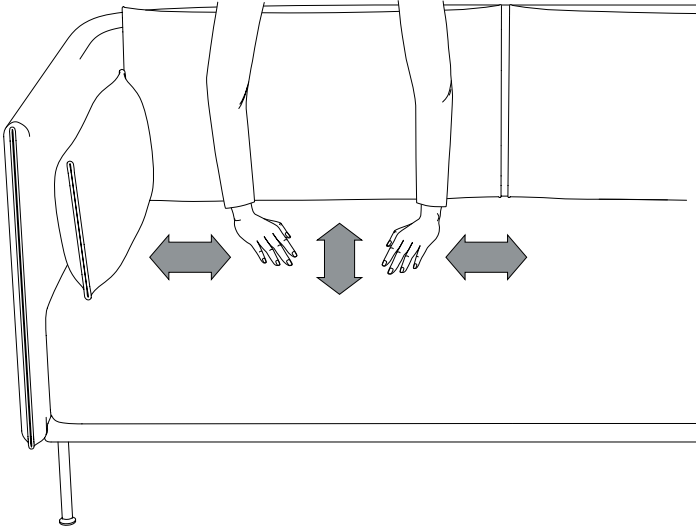

7.

Plump the cushions regularly.

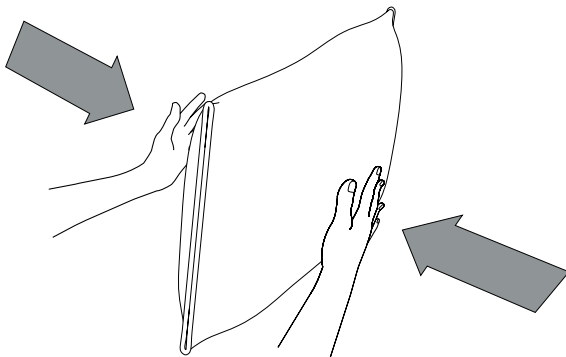

- CARE & MAINTENANCE -

Our Care & Maintenance offers guidance for optimal maintenance of your HAY product. It includes advice and instructions on cleaning and caring for specific materials to prolong the life of your furniture.



Please find our Care & Maintenance guide by scanning the QR code



You can find more relevant information on Silhouette by scanning the QR code

You can also find the same information here
hay.dk/downloads

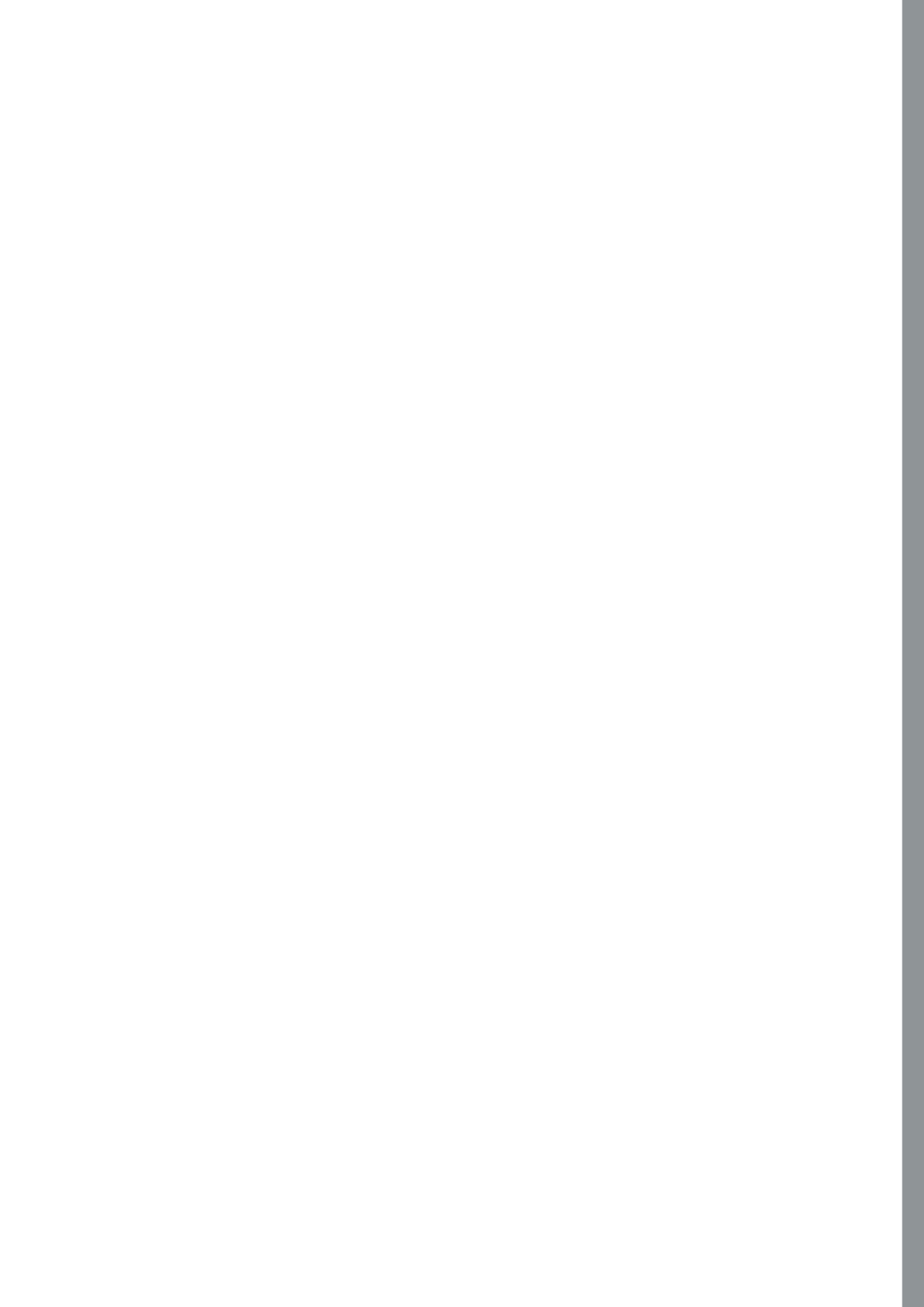

Havnen 1 8700 Horsens Denmark
+45 4282 0282 / hay@hay.com

14/10/2021

HAY