

INSTRUCTION MANUAL

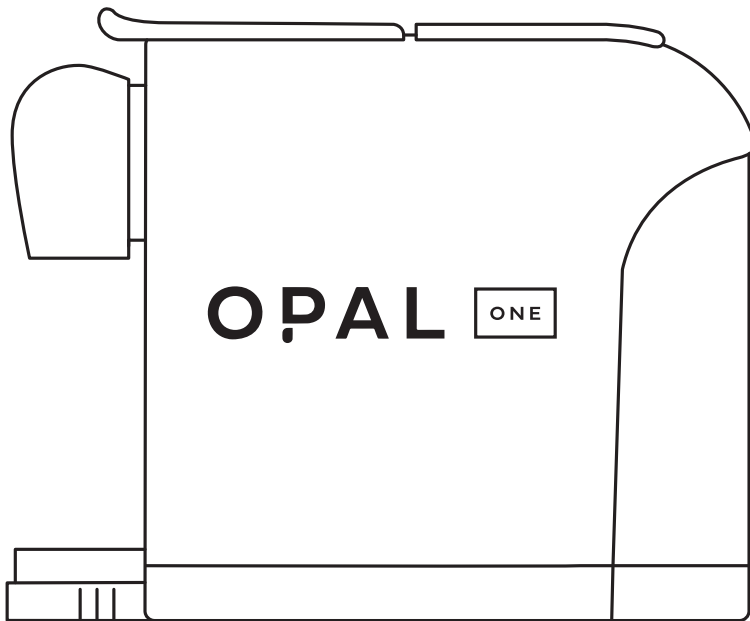

Please read this Instruction Manual and the safety instructions before operating the appliance

MODEL: OPAL01

Espresso Coffee Maker with Nespresso Capsule

Congratulations on your purchase!

This espresso coffee maker is manufactured with the greatest care. If you look after it properly it will reward you with many years of good service.

Before using your new machine, please read this operating manual carefully, paying particular attention to the safety precautions.

Content

- Safety Precautions
- Notes on this operating manual
- Unpacking
- Starting up
- Capsule type can be used
- Overview of machine parts and controls
- Definition of lighting
- Fill/refill water
- Flushing out the machine/internal piping/first use
- Mode of temperature selection
- Brewing coffee
- Refill internal circuit when water tank is out of water during brewing
- Programming the coffee volume
- Energy saving mode
- Cleaning
- Factory reset
- Steaming out/Storage/Transport
- Decalcification
- Trouble Shooting
- Technical data

Safety Precautions

Please take time to read these safety precautions carefully before connecting your machine to the power supply. It is essential to follow them and the operating instructions.

- First read this entire operating manual.
- Danger of electric shock! Never immerse the machine in water or any other liquid.
- Connect only to a properly grounded power point.
- To make sure that the machine is switched off, remove the plug from the power point.
- Always pull out the power plug before:
 - * Relocating the machine
 - * Cleaning or maintenance
 - * Long periods of disuse
- Never clamp or run the power cable over sharp corners or edges.
- Danger of electric shock! Damaged power cables may only be replaced at the customer service centre.
- Danger of electric shock! Never touch the power plug/socket/cable or the machine with damp or wet hands. Never unplug by pulling out the power cable; always remove the plug.
- If you need an extension cable, make sure it is suitable for your machine and lay the cable to avoid tripping.
- Danger of scalding! Never move the machine during operation!
- Never operate the machine without water.
- Always make sure there is water in water tank not less than minimum level.
- Danger of burning! Never touch very hot parts of the machine (e.g. brew unit during operations).
- Danger of scalding! Do not touch the steam or water jets.
- Danger of scalding! Do not move the operating lever when the machine is still under pressure making coffee.

– Do not use the machine in case of:

- faulty operation
- damaged power cable
- after falling or other damage

In such cases immediately have the machine checked and repaired if necessary at the customer service centre.

– The machine location must meet the following requirements:

- Choose a dry, stable and level support surface not immediately underneath the power point, at least 60 cm away from the washbasin and taps.
- Never place on flammable/fusible surfaces or equipment.
- Never place the machine or power cable on or nearer than 50 cm to hot surfaces or open flames.
- Never cover the machine during operation
- Keep children away from the machine during operation.
- Only use the machine in dry rooms.
- Danger of tripping! Do not let the power cable hang down.
- This machine is only intended for household use.
- Pull out the power plug and allow the machine to cool down completely before cleaning and or maintenance.
- To prevent damage, never use replacement parts or accessories not recommended by the manufacturer.
- Persons, including children, who in view of the level of their physical, sensory or mental capacities, or their lack of experience or knowledge, are not in a position to use the equipment with safety, may not use the equipment without supervision or instruction from a responsible person.

Notes on this operating manual

This operating manual cannot cover all possible circumstances. For further information or in case of problems not adequately covered in this operating manual, please contact the service and sales centre.

Please keep this operating manual safe and pass it on to the next user.

Unpacking

- Remove your espresso capsule coffee machine from its packaging
- After unpacking, please check that the following parts are included:
 1. Water tank
 2. Coffee machine
 3. Manual

Note:

- Check that your home power supply voltage is the same as marked on the machine rating plate .
- Destroy all the plastic bags to prevent danger to children!

Tip:

Keep the packaging for transporting the machine(e.g. for removals, servicing, etc.)

Note:

You may find a little water remaining in the machine.

In order to ensure that this machine works perfectly, it was tested with water before leaving the factory.

Starting up

Before using for the first time

Caution: improper handling of electrical equipment is dangerous and can be lethal. Please pay attention to the safety precautions in this manual, in particular the following:

- Danger of scalding: beware of hot water!
- Do not operate the machine with an empty water tank or water is less than MINIMUM level.
- Do not open the handle when the machine is brewing.
- Always pull out the power plug before cleaning the machine.
- Only use the machine in a dry room.

Thoroughly rinse out the water tank with fresh water before using for the first time or after long pauses (e.g. holidays).This short procedure can flush out and cleans the internal piping thoroughly. Clean the capsule coffee machine using a damp cloth only.

Capsule type can be used

-This capsule coffee machine can use A MODO MIO or certain compatible capsules, if you are going to use the latter, please contact service to check if the type of your compatible capsule has been verified by manufacturer or not, the machine does not work with all compatible capsules.



Short espresso button



Normal espresso button

Lungo Espresso button

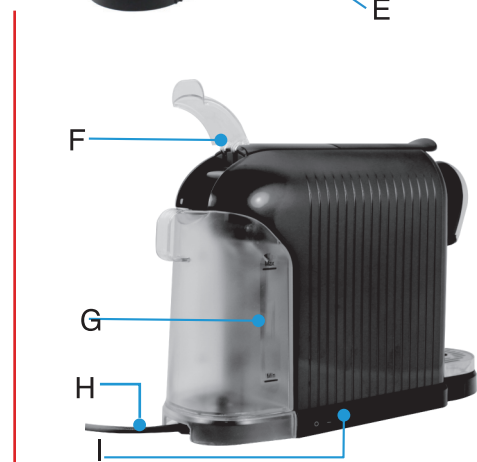



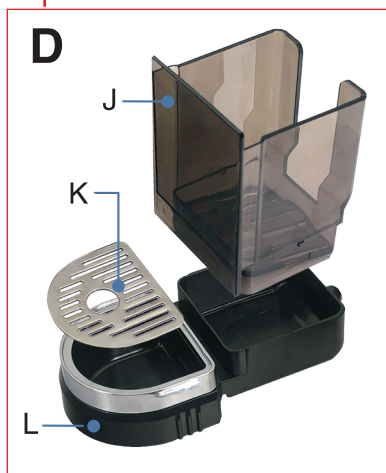



Adjustable dispenser spout
 (2 positions)



No.	Name
A	Handle
B	Buttons
C	Dispenser
D	Drip tray set
E	Wall
F	Water tank cover
G	Water tank (removable)
H	Power cord
I	Main switch
J	Used Capsule Container
K	Drip Tray Cover
L	Drip Tray(removable)

Definition of lighting

Name	Status	Function	Action
Indicator		Blink in first use.	Refer to “flushing out the machine and internal piping”
		Light steady/Water tank is empty.	Fill up water tank, open handle, then press any button to fill the internal circuit.
		Light steady	Stand-by
Button light		Blinking when warming up.	Wait for ready
		Light steady	Ready
		Each button blinks circularly.	In energy saving mode.
Light in used capsule container		Light steady when handle is open.	Check if the used capsule container is full or not.

Fill/refill water.



There are two ways to fill the water tank: directly into the machine, by using for example a jug, or by removing the water tank.

Filling without removing the tank

- Raise the water tank lid
- Fill the tank up to the “MAX” mark with cold fresh water (the maximum capacity is 0.8 litre), or at least the “Min” mark .
- Lower down the lid

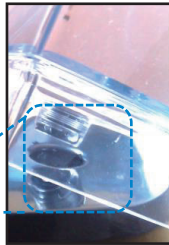

Filling by removing the water tank

- Hold the water grip at tilting angle as shown in direction 1 to remove the water tank from the machine.
- Fill the tank up to the “MAX” mark with cold fresh water (the maximum capacity is 0.8 litre). or at least the “Min” mark .
- Slide the water tank slowly on water tank base, when the water tank outlet is inserted in the inlet receptacle, pushing firmly on the water grip as shown in direction 2 to lock the water tank .

Flushing out the machine and internal piping/first use



Fill water tank to maximum level.



Plug in the appliance and turn it on.



The lights on the control buttons are blinking , blue lights in used-capsule container is lighted in blue which goes off after 1 minute .



Tips: you can check easier if the used container is full or not when the blue light is on.

The indicator will blink in red for first use, meaning the internal circuit is empty. Please fill up water tank and open the handle, press any button to start pump, once water is detected entering the internal circuit, the red indicators becomes blue.



The machine starts to heat up automatically when detected water in circuit with 3 buttons blinking.



The lights on buttons become steady when the machine is heated up, heating up time is 40 seconds approximately.

Press the lungo coffee button, before pressing the button, make sure that:

- The handle is closed without capsule inside.
- The water tank is full.
- The water tank is in place before brewing. Because there is hot cleaning water come out during heating up. Beware of hot water : danger of scalding!
- The drip tray with the used capsule container is completely inserted (never operate the machine without drip tray set (part D shown in "Overview of machine parts and controls"), or hot water will run out when opening handle.
- A large bowl (250ml size or above) is placed under the dispenser.
- Press the lungo button to start flush out.
- Open the handle when the flush out process stopped automatically.
- Empty the cup.
- Flush out cycle is finished.



Mode of temperature setting

If you want to adjust different temperature for brewing coffee ,you can have the operation as below indication:

1. Press the short espresso & normal espresso buttons together and keep the buttons pressed.
2. Switch on the machine while the short espresso & normal espresso buttons are pressed, release the buttons after 3 seconds or when you hear 2 beeps. Then the indicator light is in red and machine enters into the mode of temperature selection.
3. The mode of temperature is below:



A. When you press on the short espresso button , the machine enters into low temperature mode. Then switch off the machine .When you switch on the machine again , the brewing coffee is in low temperature.

OR



B. When you press on the normal espresso button ,the machine enters into normal temperature mode. Then switch off the machine .When you switch on the machine again , the brewing coffee is in normal temperature.(Factory default setting)

OR



C. When you press on the lungo espresso button ,the machine enters into high temperature mode. Then switch off the machine .When you switch on the machine again , the brewing coffee is in high temperature. There will be more steam during heating up and after brewing coffee ,when you choose this mode of temperature.

Brewing coffee

*Make sure the water tank is in place before brewing. Because there is hot cleaning water come out during heating up. Beware of hot water : danger of scalding!

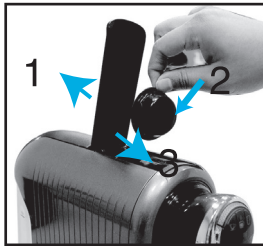

– Place an empty cup under the dispenser. For small cups, low down the dispensing spout.

1. Move the handle back completely.
2. Insert a capsule to fall straight into the compartment correctly.
3. Close the handle firmly to load the capsule .
4. Press the desired coffee button only once.
5. The selected button will blink and the machine is brewing coffee, dispensing will stop automatically when reaching the default brewing volume (25ml for short espresso, 40 for normal espresso, 110ml for lungo espresso), default setting can be programmed, please refer to “how to program volume”.

6. Raise the handle to eject the used capsule into the container.

7. Close the handle.

Tips: *When using the cold machine (for example, using the machine in the morning or idle time longer than 1 hour), it is suggested to brew water first in order to remove the residual taste of the last cup.

* When brewing is finished ,a little water will be discharge to the water tank, it is clean water and still drinkable.

Refill internal circuit when water tank is out of water during brewing

* It is strongly suggested to be sure there is enough water in the tank before making coffee, minimum level at least.

In case water is running out during coffee brewing, you can stop it by pressing the selected button which is blinking.

Open the handle to eject the used capsule. CAUTION: Beware of hot steam: danger of scalding!

Fill up water tank and press one of the buttons to start pumping water, once the circuit is refilled, the indicator light turns from red to blue.

Programming the coffee volume.

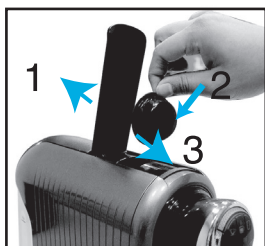

Be sure there is enough water in the tank and the water tank is firmly in place before programming coffee volume. Place an empty cup under the dispenser. For small cups, low down the dispensing spout.

1. Raise the handle back completely.
2. Insert a capsule into the compartment gently.
3. Close the handle firmly to load the capsule .
4. Press the desired button and keep it pressed down, once the desired volume has been reached, release the button, now the button is reprogrammed.
5. After the programming, the size will be recorded in memory. For next use, by clicking the button normally (ie, press once.)



Do the same for other buttons if required.

OR



Default size is 25ml (short espresso), 40ml (normal espresso), and 110ml (Lungo espresso).

OR



Tips: When programming process is finished, leave the machine for 30 seconds for cool down prior to open handle.

The blinking frequency is 1 second 1 blink, hence, you can counter the blinking to know the brewing time.

Energy saving mode.

The machine enters energy saving model automatically once the machine is idle for 15 minutes, the 3 buttons will flash cyclically in energy saving mode.

To quit energy saving mode, please press any button, appliance will start to warming up with lights blinking, when the buttons are lit steadily, the machine is ready to brew coffee.

Cleaning

Emptying the capsule container and drip tray

The capsule container holds around 10 used capsules.

We recommend emptying the used capsule container and the drip tray every day, you can see if the used capsule container is full or not while the blue light is on in the used capsule container.



1. Raise the handle to ensure there is no capsule inside the brewing compartment.
2. Raise the dispensing spout up if it is in low position.
3. Hold the drip tray firmly and pull it out by lifting gently.
4. Dispose of used capsules and drip tray.
5. The used capsule container can be detached, if necessary, from the lower drip tray (snaplock).
6. Rinse out the drip tray set with fresh water.
7. Remove the water from the appliance, rinse out the water tank with fresh water.
8. After emptying/cleaning, reassemble the parts in reverse order and insert them back to machine in place.

Important: the plastic parts of the machine are not dishwasher safe.



- Always pull out the power plug before cleaning the machine.
- Never immerse the machine in water or clean it under running water.
- Clean the machine with a dry cloth.
- Never use abrasive cleaning agents or materials (use e.g. dry rags or kitchen paper).

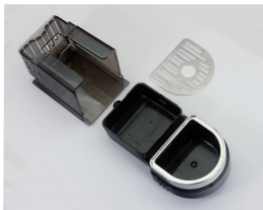

Factory Reset



In case you want to have the default setting of the machine, please follow below instruction:

- a. Turn off the machine.
- b. Press the lungo button and keep the button pressed.
- c. Switch on the machine while the lungo button is pressed, release the button after 3 seconds or when you hear 2 beeps, the reset is done.

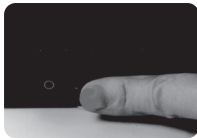

d. After above operation, the machine is reset to factory default setting the following parameters are reset:

- Coffee brewing size,
 - 25ml
 - 40ml
 - 110ml

Tips: Make the reset when machine is warmed up so that you can see flash signal easier.

Steaming out / Storage / Transport



Steaming out

- Prior to long periods of disuse or for storage or transport at temperatures below 5 °C, it is essential to steam out the machine. This removes water from the system to prevent internal frost damage.
- Turn on the machine.
- Empty the water tank and place it in its position.
- Put an empty cup under the coffee dispensing spout.
- press “lungo” button to start brewing.
- Steaming out now commences.
- After the pump stops automatically, the steaming out process is completed.
- Turn off the machine and unplug.

CAUTION:

- Beware of hot steam: danger of scalding!

Decalcification

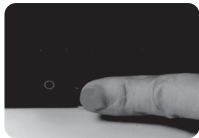

Decalcification / Maintenance

Drinking water varies according to region. The lime particles in hard drinking water are deposited as residues in the machine and can block the piping and cause damage. To prevent this, be sure to decalcify the machine at the very least after making 300 to 400 cups of coffee or, in any case if the output falls significantly or, after one or two months. Decalcification must be done correctly to prevent damage. So it is essential to follow these instructions.

Important:

- Never clean the machine with vinegar. This causes damage and makes your coffee taste bad.
- Damage caused by incorrect decalcification or failure to decalcify is not covered by the guarantee.
- Caution: beware of hot water!
- Recommendations: purchase commercially available decalcifier (decalcifying liquid), diluted according to the manufacturer's instructions; pour the mixture in the water tank.
- Make sure there is not a capsule inside the machine.
- Place a large bowl under the dispensing head to collect the decalcification diluted and lime residues
- Fill the water tank with water to maximum level mixed with decalcifying solution, make sure the solution is dissolved completely.
- Turn off the main switch, Press the short espresso button and hold it pressed down , turn on the main switch simultaneously, release the short espresso button once 2 beeps emitted, the indication light is in red.
- Press the short espresso button to start the pump.
- The machine will run out 2 tanks of water for the decalcification process, after running out the 1st tank of water, there is one "beep" to remind to fill in the water tank with decalcifying solution to the maximum level, once filled, press the button again, the machine will go on the procedure automatically , the red light becomes blue once the cycle is finished.
- Repeat the process to Flush out the internal circuit with 2 tank of fresh water (without the decalcifying solution) to clean the internal circuit completely.
- Turn off the main switch.
- The decalcifying process is completed.

Tips: During decalcifying process, if you need to empty the bowl under the dispenser, you can press the button for pause, press it again to continue.

Trouble Shooting

PROBLEM	CAUSE	SOLUTION
No coffee is brewed.	The water tank is empty.	Fill water in the water tank.
The coffee is not hot enough.	-the Cold cups / mugs. - Scale build-up in machine.	Preheat cup / mug. - Descale. - For cold machine, brewing a cup of water to warm up the circuit.
Capsule can't drop down	-The used capsule container is full. -The capsule is deformed after brewing.	Empty the used capsule container. - Push it down with finger, or close the handle and open it once again.
steam when handle opened.	- Opened the handle too quick when brewing finished.	- Leave a few seconds to let the residual pressure to escape.
Water on table	-Water tank is leaking. -- drip tray is full of water. -- when brewing finished, opened the brewing chamber without drip tray set in place.	-Check if the valve on water tank is stuck. --empty the drip tray. -- make sure the drip tray set is in place.
Capsule dropped down directly to used capsule container.	-Capsule deformed	-try it again with slight different angle. -use a new capsule.
Occasional drops drip out of the dispensing head	-the heater is keeping warm.	-Occasional drops are normal, it is not a defect
Coffee comes out in drips/ coffee goes into the used capsule container.	- the ground coffee in capsule is too fine to pass water.	Change to a new capsule. Suggest to use A MODOMIO capsule or MODO MIO compatible capsule.

Technical data

Rated Voltage: 220-240VAC 100V
Rated Frequency: 50/60Hz
Rated Power: 1,260W
N.W./G.W.: 3.1/3.5 kg appr.
Pump Pressure: Max. 19 Bars
Water Tank Capacity: 0.8L
Size: 118mm(W)* 365mm(L) * 250mm(H)
Protection Class: I

Right for improvements changes are reserved in the interest of technical progress.