

FLOS

■ F1370031 Matte Black

Smithfield Ceiling

Designed by Jasper Morrison, 2009



Halogen - 4 x 70W

Ceiling-mounted lamp providing direct light. Aluminium body. Available in gloss black, white, matte black, green, red or MUD. Injection-moulded opalescent methacrylate diffuser. Steel wall and ceiling attachment.

Are you a professional and your project needs consulting and support?

[BOOK AN APPOINTMENT](#)

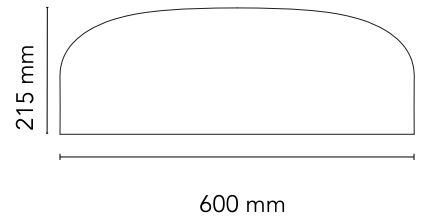

Main specifications

EAN	8059607031315
Mounting	Ceiling
Environments	Indoor dry location
Light Source Type	Bulb
Lamp category	Halogen
Lamp type	A70
Lamp holders	E27
Iicos	HSGSA
Bulb finish	Frosted
Number of heads	4
Power (W)	70
System power (W)	280

Physical

Colour	Matte Black
Length (mm)	600
Net weight (kg)	4.5
Package height (mm)	310
Package width (mm)	710
Package length (mm)	710
Package volume (m3)	0.16
IP internal	20

Download

[Mounting instructions](#)  PDF

[Spare Parts](#)  PDF



Schematic light drawing

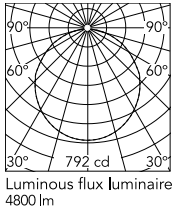

Photometric

Lighting type	Direct
Light distribution	Roto symmetric

Electrical

Insulation class	I
Frequency (Hz)	50/60
Main voltage (Vac)	220-250
Dimmable	Yes
Dimming interface	Remote Dimmable (Dimmer Not Included)
Batteries inside	No

Bulbs

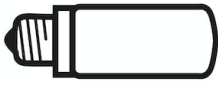

NOT INCLUDED

RF32288

LED Lamp E27 15W 2700K T38

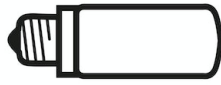

NOT INCLUDED

RF32289

LED Lamp E27 15W 3000K T38



NOT INCLUDED

RF32563

LED Lamp 11.5W E27 220-240V
2700K A70

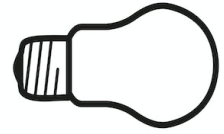

NOT INCLUDED

RF32564

LED Lamp 11.5W E27 220-240V
3000K A70



NOT INCLUDED

RF26259

LED Lamp 18W E27 2700K
Dimmable



NOT INCLUDED

RF26258

LED Lamp 18W E27 3000K T38
Dimmable

Spare Parts

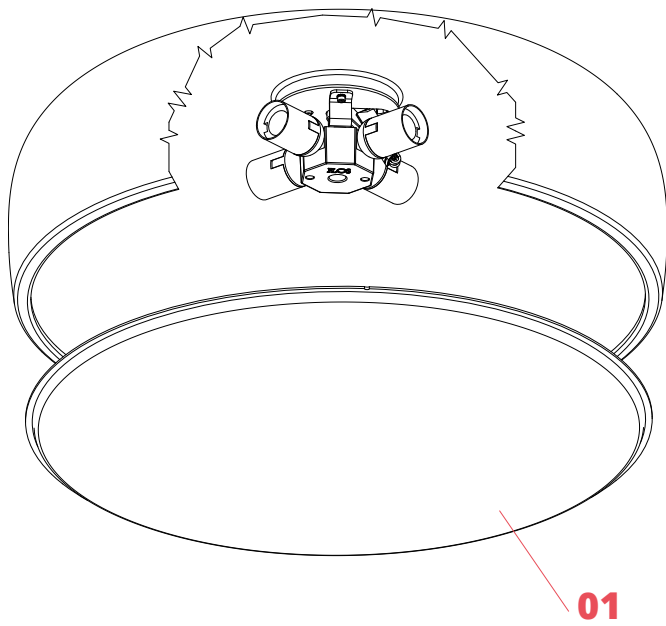

01. Methacrylate diffuser

RF19022

DOWNLOAD

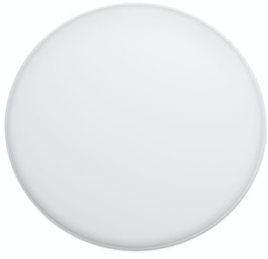

RF19022

Methacrylate diffuser