

# Frame

## Kitchens & workbenches

Salvatore Indriolo, 2018-26



archiproducts  
AWARDS  
WINNER

archiproducts  
AWARDS  
WINNER  
SUSTAINABILITY



**Kitchens and workbenches featuring a visible support frame with inset doors and drawers, expressing a minimal design language.**

**Frame** made of 35 x 35 mm (1.38" x 1.38") square tube. Concealed levelling feet, laterally adjustable.

**Top** in AISI 304 stainless steel, 4 mm (0.16") thick, with satin or Vintage finish (Barazza manual processing). Also available with integrated sinks and equipment channels. Alternatively: porcelain stoneware top, 12 mm (0.47") thick; AISI 304 stainless steel top, 3 mm (0.12") thick, powder-coated to match the frame; extra-clear glass top, 6 mm (0.24") thick, etched, with matt ground edge and back-painted in the 35 Fantin finishes.

**Doors** inset in the frame, in double bent sheet metal, thickness 20 mm (0.79"). Metal handles powder-coated to match the doors. Soft-close hinges. 95° opening.

**Drawers** with fronts inset in the frame, thickness 20 mm (0.79"), in double bent sheet metal. Metal handles powder-coated to match the fronts. Hettich runners with integrated stabilization and soft-close systems. Load capacity 40 kg (88.18 lb).

**Sides and bases** inset in the frame, in bent sheet metal; filled sides. Internal shelves in bent sheet metal.

**Optional back panels** in metal, inset in the frame.

**Optional accessories:** stainless steel sinks; roll-up draining mat; taps; shelves; open compartments; panelling; wheel kit with discs matching the frame; internal shelves in bent sheet metal.

*Kitchens are supplied assembled (tops excluded).*

*Also available for outdoor use. See p. 216.*

**Cucine e banconi caratterizzati dal telaio portante in vista e ante e cassetti in luce, espressione di un design minimale.**

**Telaio** in tubolare quadrato 35 x 35 mm (1.38" x 1.38"). Piedini livellatori nascosti, regolabili lateralmente.

**Top** in acciaio inox AISI 304, spessore 4 mm (0.16"), con finitura satinata o Vintage (lavorazione manuale Barazza). Disponibile anche con vasche e canali attrezzati integrati. In alternativa: top in grès porcellanato, spessore 12 mm (0.47"); top in acciaio inox AISI 304, spessore 3 mm (0.12"), verniciato a polveri in tinta con il telaio; top in vetro extra-chiaro, spessore 6 mm (0.24"), acido, con bordo filo-opaco e retroverniciato nelle 35 finiture Fantin.

**Ante** in luce al telaio, in doppia lamiera piegata, spessore 20 mm (0.79"). Maniglie in metallo verniciate in tinta con le ante. Cerniere ammortizzate. Apertura 95°.

**Cassetti** con frontali in luce al telaio, spessore 20 mm (0.79"), in doppia lamiera piegata. Maniglie in metallo verniciate in tinta con i frontali. Guide Hettich con sistemi di stabilizzazione e soft-close integrati. Portata 40 kg (88.18 lb).

**Fianchi e fondi** in luce al telaio, in lamiera piegata; fianchi tamponati. Ripiani interni in lamiera piegata.

**Schiene opzionali** in metallo, in luce al telaio.

**Accessori opzionali:** vasche in acciaio inox; griglia multiuso avvolgibile; rubinetti; mensole; vani a giorno; boiserie; kit ruote con dischi in tinta con il telaio; ripiani interni in lamiera piegata.

*Le cucine sono fornite montate (top esclusi).*

*Disponibile anche per uso esterno. Vedi pag. 216.*

**Küchen und Werkbänke mit sichtbarem Tragrahmen sowie bündig eingesetzten Türen und Schubläden, Ausdruck eines minimalistischen Designs.**

**Gestell** aus Vierkantrrohr 35 x 35 mm (1.38" x 1.38"). Unsichtbare, seitlich verstellbare Nivellierfüße.

**Arbeitsplatte** aus Edelstahl AISI 304, Stärke 4 mm (0.16"), mit Satin- oder Vintage-Finish (manuelle Verarbeitung Barazza). Auch verfügbar mit integrierten Becken und Funktionskanälen. Alternativ: Arbeitsplatte aus Feinsteinzeug, Stärke 12 mm (0.47"); Arbeitsplatte aus Edelstahl AISI 304, Stärke 3 mm (0.12"), pulverbeschichtet in Rahmenfarbe; Arbeitsplatte aus extra-klarem Glas, Stärke 6 mm (0.24"), geätzt, mit matt geschliffener Kante und rückseitig lackiert in den 35 Fantin-Farben.

**Türen** bündig im Gestell, aus doppelt gekantetem Blech, Stärke 20 mm (0.79"). Metallgriffe pulverbeschichtet in Türfarbe. Gedämpfte Scharniere. Öffnungswinkel 95°.

**Schubladenfronten** bündig im Gestell, Stärke 20 mm (0.79"), aus doppelt gekantetem Blech. Metallgriffe pulverbeschichtet in Frontfarbe. Hettich-Führungen mit integrierten Stabilisations- und Soft-Close-Systemen. Tragfähigkeit 40 kg (88.18 lb).

**Seiten und Böden** bündig im Gestell, aus gekantetem Blech; geschlossene Seiten. Innenböden aus gekantetem Blech.

**Optionale Rückwände** aus Metall, bündig im Gestell.

**Optionales Zubehör:** Edelstahlbecken; aufrollbare Abtropfmatte; Armaturen; Regale; offene Fächer; Verkleidungen; Radsatz mit farblich abgestimmten Scheiben; Innenböden aus gekantetem Blech.

*Küchen werden montiert geliefert (Arbeitsplatten ausgeschlossen).*

*Auch für den Außenbereich verfügbar. Siehe S. 216.*

Bases L128 / Basi L128 / Basen L128

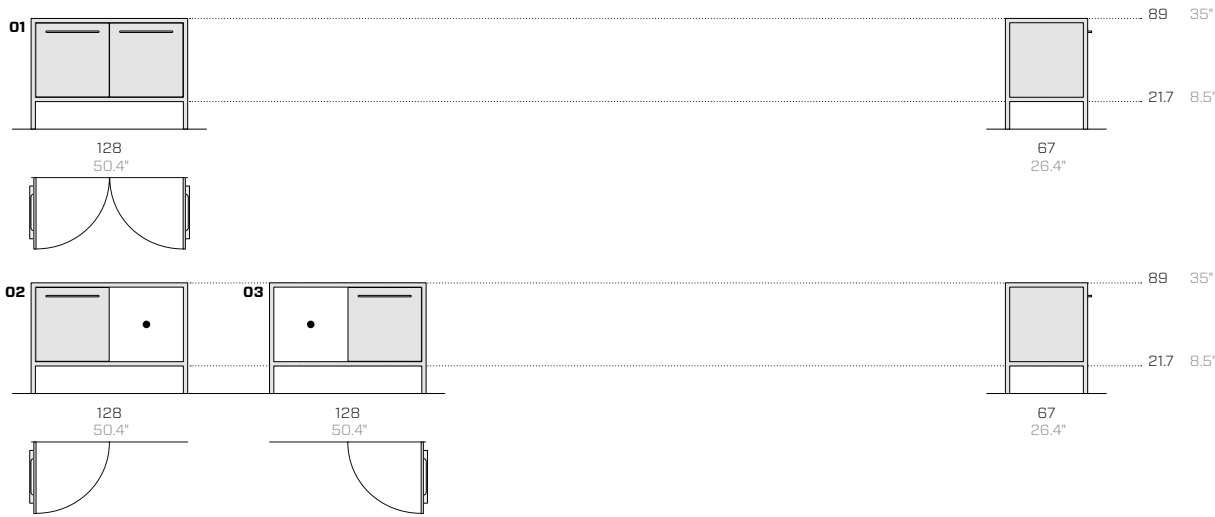

Bases L128 for refrigerator / Basi L128 per frigorifero / Basen L128 für Kühlschrank

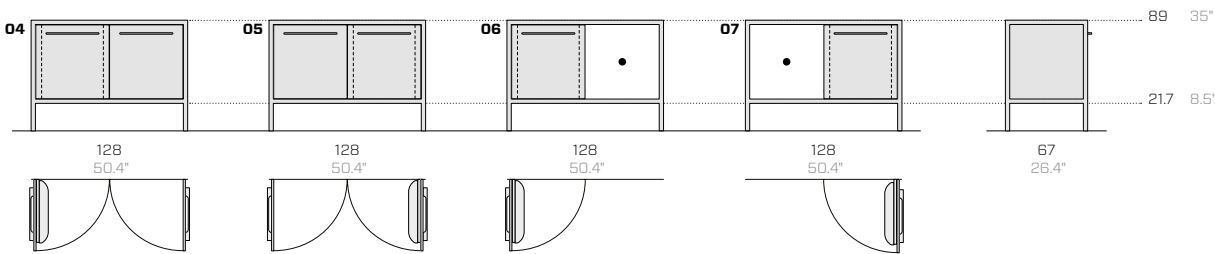

Bases L128 for dishwasher / Basi L128 per lavastoviglie / Basen L128 für Geschirrspüler

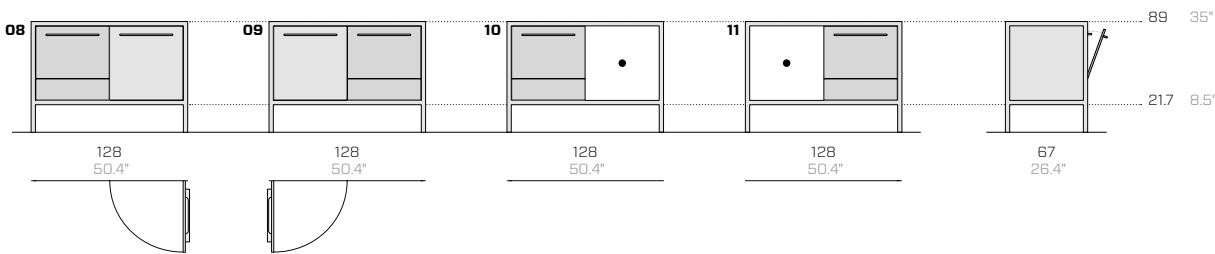

Bases L128 for refrigerator and dishwasher / Basi L128 per frigorifero e lavastoviglie / Basen L128 für Kühlschrank und Geschirrspüler

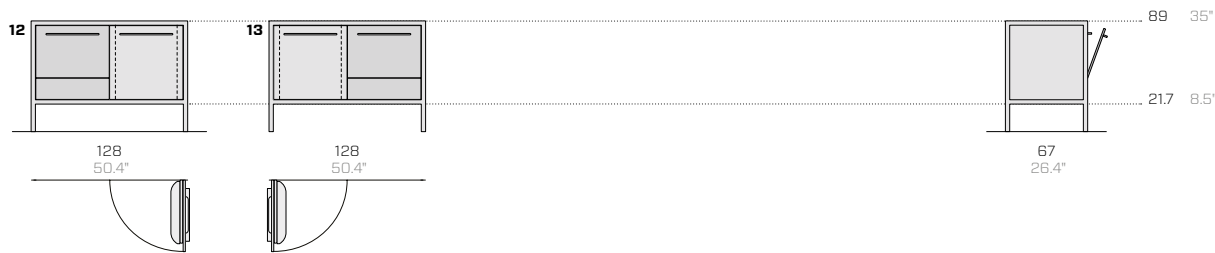

• Compartment for household appliances without Fantin door / Vano per elettrodomestici senza anta Fantin / Fach für Haushaltsgeräte ohne Fantin-Tür

Product / Prodotto / Produkt

No. / No. / N°	Price / Prezzo / Preis	Code / Codice / Code	Dimensions (w-d-h) / Dimensioni (l-p-h) / Abmessungen (b-t-h)	Weight / Peso / Gewicht	Dimensions (w-d-h) / Dimensioni (l-p-h) / Abmessungen (b-t-h)	Weight / Peso / Gewicht	Vol pkg / Vol. collo / Vol. Kollo	
				cm	kg	cm	kg	mc

Bases L128 / Basi L128 / Basen L128

01	-	FR201AA	128 67 89	59	150 80 107	91	1.30
02	-	FR202AV	128 67 89	52	150 80 107	84	1.30
03	-	FR207VA	128 67 89	52	150 80 107	84	1.30

Bases L128 for refrigerator / Basi L128 per frigorifero / Basen L128 für Kühlschrank

04	-	FR213FA	128 67 89	61	150 80 107	93	1.30
05	-	FR203AF	128 67 89	61	150 80 107	93	1.30
06	-	FR214FV	128 67 89	54	150 80 107	86	1.30
07	-	FR209VF	128 67 89	54	150 80 107	86	1.30

Bases L128 for dishwasher / Basi L128 per lavastoviglie / Basen L128 für Geschirrspüler

08	-	FR219LA	128 67 89	62	150 80 107	94	1.30
09	-	FR204AL	128 67 89	62	150 80 107	94	1.30
10	-	FR220LV	128 67 89	55	150 80 107	87	1.30
11	-	FR210VL	128 67 89	55	150 80 107	87	1.30

Bases L128 for refrigerator and dishwasher / Basi L128 per frigorifero e lavastoviglie / Basen L128 für Kühlschrank und Geschirrspüler

12	-	FR221LF	128 67 89	64	150 80 107	96	1.30
13	-	FR216FL	128 67 89	64	150 80 107	96	1.30

Drawer kits (surcharge on the door price) / Kit cassetti (sovrapprezzo costo anta) / Schubladen-Set (Zuschlag auf den Türpreis)

A1	-	FRK25C1	60 55 60	12	63 58 63	13	0.30
A2	-	FRK26C2	60 55 60	18	63 58 63	19	0.30

Inner drawer / Cassetto interno / Innenfach

A3	-	FRK27C1	55 55 9.4	4	60 60 20	5	0.10
----	---	---------	-----------	---	----------	---	------

"Metal Design" finishes: 15% surcharge / Finiture "Metal Design": maggiorazione del 15% / "Metal Design"-Oberflächen: 15% Aufschlag

The packaging details are for products that require assembly / I dati di imballo si riferiscono al prodotto smontato / Die Verpackungsdaten beziehen sich auf das unmontierte Produkt

Drawer kits / Kit cassetti / Schubladen-Set



Kit 1 large drawer  
Kit 1 cassettone  
Set 1 Kommode



Kit 2 drawers  
Kit 2 cassetti  
Set 2 Schubladen



Kit 1 large drawer + 1 inner drawer  
Kit 1 cassettone + cassetto interno  
Set 1 Kommode + 1 Innenfach



Kit 2 drawers + 1 inner drawer  
Kit 2 cassetti + cassetto interno  
Set 2 Schubladen + 1 Innenfach

Bases L188 / Basi L188 / Basen L188

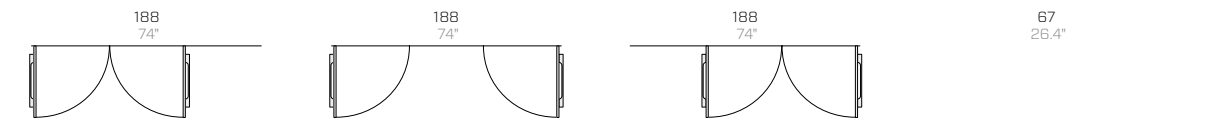
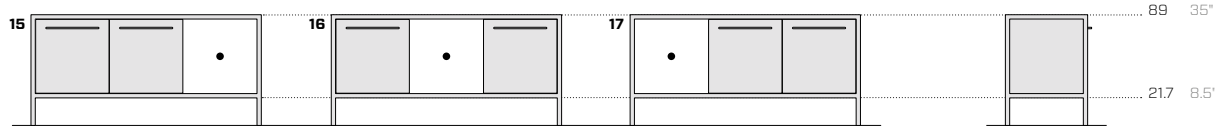

Bases L188 for refrigerator / Basi L188 per frigorifero / Basen L188 für Kühlschrank

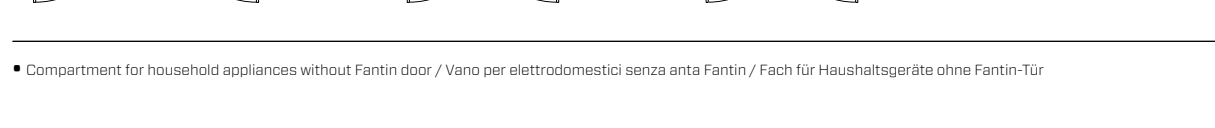
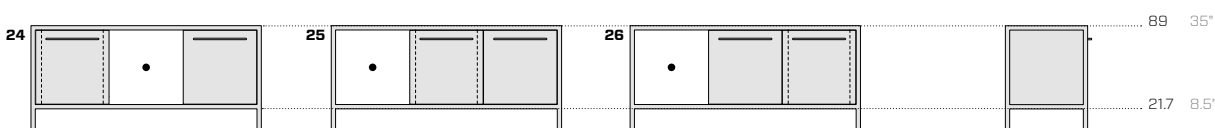
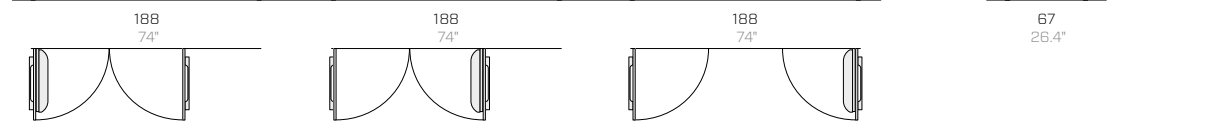
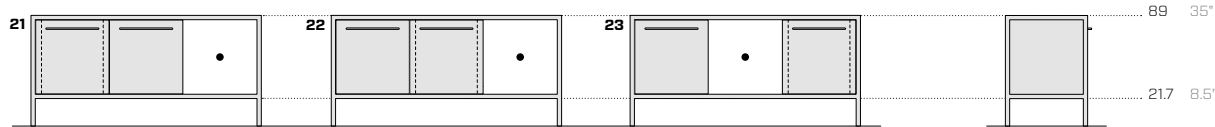
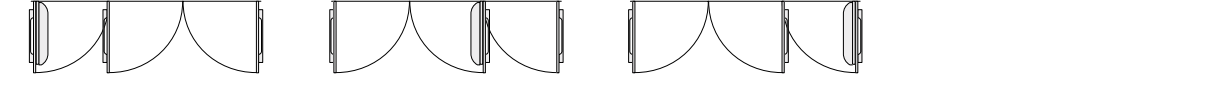
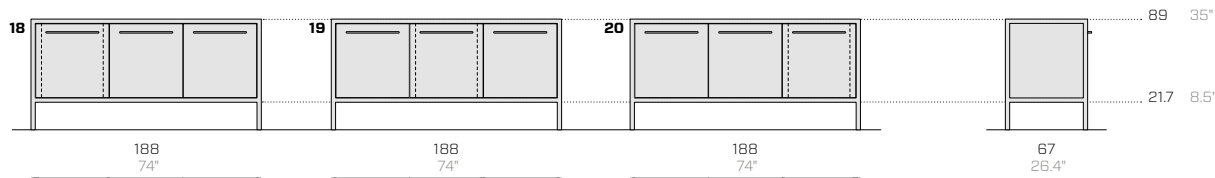

• Compartment for household appliances without Fantin door / Vano per elettrodomestici senza anta Fantin / Fach für Haushaltsgeräte ohne Fantin-Tür

Product / Prodotto / Produkt

No.	Price	Code	Dimensions (w-d-h)	Weight	Dimensions (w-d-h)	Weight	Vol pkg
No.	Prezzo	Codice	Dimensioni (l-p-h)	Peso	Dimensioni (l-p-h)	Peso	Vol. collo
N°	Preis	Code	Abmessungen (b-t-h)	Gewicht	Abmessungen (b-t-h)	Gewicht	Vol. Kollo
	euro		cm	kg	cm	kg	mc

Bases L188 / Basi L188 / Basen L188

14	-	FR301AAA	188 67 89	66	200 80 107	109	1.80
15	-	FR302AAV	188 67 89	59	200 80 107	102	1.80
16	-	FR307AVA	188 67 89	59	200 80 107	102	1.80
17	-	FR337VAA	188 67 89	59	200 80 107	102	1.80

Bases L188 for refrigerator / Basi L188 per frigorifero / Basen L188 für Kühlschrank

18	-	FR373FAA	188 67 89	68	200 80 107	111	1.80
19	-	FR313AFA	188 67 89	68	200 80 107	111	1.80
20	-	FR303AAF	188 67 89	68	200 80 107	111	1.80
21	-	FR374FAV	188 67 89	61	200 80 107	104	1.80
22	-	FR314AFV	188 67 89	61	200 80	104	1.80
23	-	FR309AVF	188 67 89	61	200 80 107	104	1.80
24	-	FR379FVA	188 67 89	61	200 80 107	104	1.80
25	-	FR349VFA	188 67 89	61	200 80 107	104	1.80
26	-	FR339VAF	188 67 89	61	200 80 107	104	1.80

Drawer kits (surcharge on the door price) / Kit cassetti (sovrapprezzo costo anta) / Schubladen-Set (Zuschlag auf den Türpreis)

A1	-	FRK25C1	60 55 60	12	63 58 63	13	0.30
A2	-	FRK26C2	60 55 60	18	63 58 63	19	0.30

Inner drawer / Cassetto interno / Innenfach

A3	-	FRK27C1	55 55 9.4	4	60 60 20	5	0.10
----	---	---------	-----------	---	----------	---	------

"Metal Design" finishes: 15% surcharge / Finiture "Metal Design": maggiorazione del 15% / "Metal Design"-Oberflächen: 15% Aufschlag

The packaging details are for products that require assembly / I dati di imballo si riferiscono al prodotto smontato / Die Verpackungsdaten beziehen sich auf das unmontierte Produkt

Drawer kits / Kit cassetti / Schubladen-Set



Kit 1 large drawer  
Kit 1 cassettone  
Set 1 Kommode



Kit 2 drawers  
Kit 2 cassetti  
Set 2 Schubladen



Kit 1 large drawer + 1 inner drawer  
Kit 1 cassettone + cassetto interno  
Set 1 Kommode + 1 Innenfach



Kit 2 drawers + 1 inner drawer  
Kit 2 cassetti + cassetto interno  
Set 2 Schubladen + 1 Innenfach

Bases L188 for dishwasher / Basi L188 per lavastoviglie / Basen L188 für Geschirrspüler

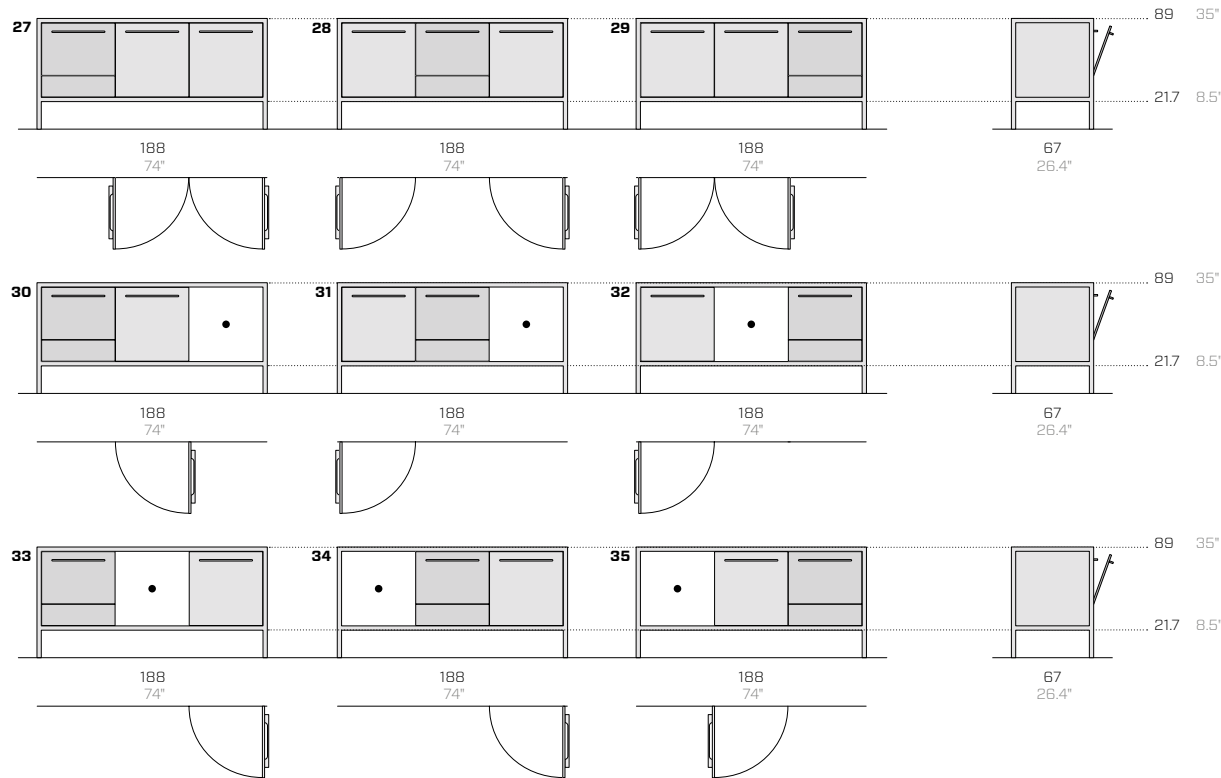

Bases L188 for refrigerator and dishwasher / Basi L188 per frigorifero e lavastoviglie / Basen L188 für Kühlschrank und Geschirrspüler

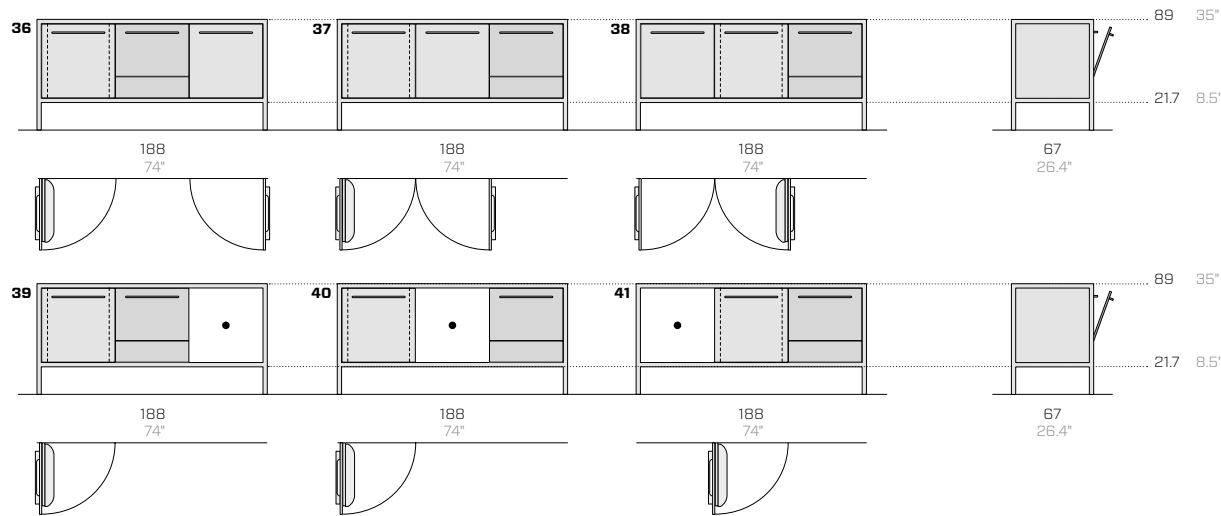

36, 37, 38, 39, 40, 41 > reversible compositions / composizioni reversibili / reversibel Zusammensetzungen

• Compartment for household appliances without Fantin door / Vano per elettrodomestici senza anta Fantin / Fach für Haushaltsgeräte ohne Fantin-Tür

Product / Prodotto / Produkt

No.	Price	Code	Dimensions (w-d-h)	Weight	Dimensions (w-d-h)	Weight	Vol pkg
No.	Prezzo	Codice	Dimensioni (l-p-h)	Peso	Dimensioni (l-p-h)	Peso	Vol. collo
N°	Preis	Code	Abmessungen (b-t-h)	Gewicht	Abmessungen (b-t-h)	Gewicht	Vol. Kollo
	euro		cm	kg	cm	kg	mc

Bases L188 for dishwasher / Basi L188 per lavastoviglie / Basen L188 für Geschirrspüler

27	-	FR409LAA	188 67 89	69	200 80 107	112	1.80
28	-	FR319ALA	188 67 89	69	200 80 107	112	1.80
29	-	FR304AAL	188 67 89	69	200 80 107	112	1.80
30	-	FR410LAV	188 67 89	62	200 80 107	105	1.80
31	-	FR320ALV	188 67 89	62	200 80 107	105	1.80
32	-	FR310AVL	188 67 89	62	200 80 107	105	1.80
33	-	FR415LVA	188 67 89	62	200 80 107	105	1.80
34	-	FR355VLA	188 67 89	62	200 80 107	105	1.80
35	-	FR340VAL	188 67 89	62	200 80 107	105	1.80

Bases L188 for refrigerator and dishwasher / Basi L188 per frigorifero e lavastoviglie / Basen L188 für Kühlschrank und Geschirrspüler

36	-	FR391FLA	188 67 89	71	200 80 107	114	1.80
37	-	FR376FAL	188 67 89	71	200 80 107	114	1.80
38	-	FR316AFL	188 67 89	71	200 80 107	114	1.80
39	-	FR392FLV	188 67 89	64	200 80 107	107	1.80
40	-	FR382FVL	188 67 89	64	200 80 107	107	1.80
41	-	FR352VFL	188 67 89	64	200 80 107	107	1.80

Drawer kits (surcharge on the door price) / Kit cassetti (sovrapprezzo costo anta) / Schubladen-Set (Zuschlag auf den Türpreis)

A1	-	FRK25C1	60 55 60	12	63 58 63	13	0.30
A2	-	FRK26C2	60 55 60	18	63 58 63	19	0.30

Inner drawer / Cassetto interno / Innenfach

A3	-	FRK27C1	55 55 9.4	4	60 60 20	5	0.10
----	---	---------	-----------	---	----------	---	------

"Metal Design" finishes: 15% surcharge / Finiture "Metal Design": maggiorazione del 15% / "Metal Design"-Oberflächen: 15% Aufschlag

The packaging details are for products that require assembly / I dati di imballo si riferiscono al prodotto smontato / Die Verpackungsdaten beziehen sich auf das unmontierte Produkt

Drawer kits / Kit cassetti / Schubladen-Set



Kit 1 large drawer  
Kit 1 cassettone  
Set 1 Kommode



Kit 2 drawers  
Kit 2 cassetti  
Set 2 Schubladen



Kit 1 large drawer + 1 inner drawer  
Kit 1 cassettone + cassetto interno  
Set 1 Kommode + 1 Innenfach



Kit 2 drawers + 1 inner drawer  
Kit 2 cassetti + cassetto interno  
Set 2 Schubladen + 1 Innenfach

Workbenches with open or closed shelves / Banconi con ripiani liberi o tamponati / Arbeitstheken offen oder geschlossen

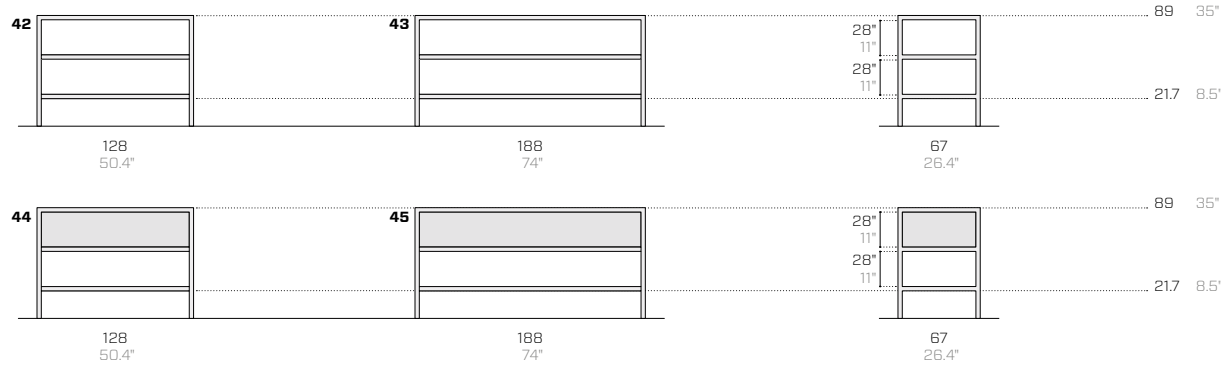

44, 45

Includes closed front and side panels (not opening; excludes back panel). For back panels and connection cover kits, see p. 68

Include fronti e fianchi tamponati non apribili (schiena esclusa). Per schiene e kit di copertura allacciamenti, vedi a p. 68

Inklusive geschlossene Front und Seiten (nicht öffnend; Rückwand ausgeschlossen). Für Rückwände und Anschlussabdeckungen siehe S. 68

Workbenches with push-pull drawer units / Banconi con cassettiere push-pull / Werkbänke mit Push-Pull-Schubladenelementen

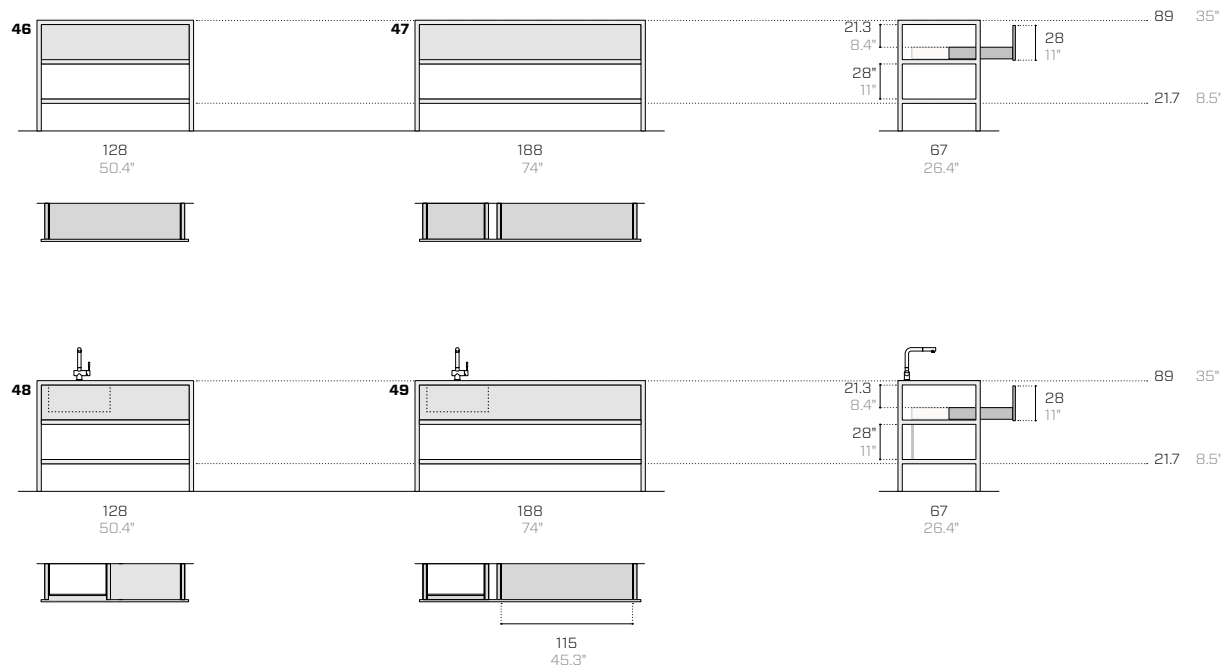

47, 48, 49: reversible compositions / composizioni reversibili / reversibel Zusammensetzungen

Product / Prodotto / Produkt

Packaging / Imballo / Verpackung

No.	Price	Code	Dimensions (w-d-h)	Weight	Dimensions (w-d-h)	Weight	Vol pkg
No.	Prezzo	Codice	Dimensioni (l-p-h)	Peso	Dimensioni (l-p-h)	Peso	Vol. collo
N°	Preis	Code	Abmessungen (b-t-h)	Gewicht	Abmessungen (b-t-h)	Gewicht	Vol. Kollo
	euro		cm	kg	cm	kg	mc

Workbenches with open or closed shelves / Banconi con ripiani liberi o tamponati / Arbeitstheken offen oder geschlossen

42	-	FR621	128 67 89	56	150 80 107	99	1.30
43	-	FR622	188 67 89	75	200 80 107	118	1.80
44	-	FR611	128 67 89	60	150 80 107	103	1.30
45	-	FR612	188 67 89	80	200 80 107	123	1.80

Workbenches with push-pull drawer units / Banconi con cassettiere push-pull / Werkbänke mit Push-Pull-Schubladenelementen

46	-	F623	128 67 89	74	150 80 107	117	1.30
47	-	F624	188 67 89	100	200 80 107	143	1.80
48	-	F625	128 67 89	78	150 80 107	121	1.30
49	-	F626	188 67 89	98	200 80 107	141	1.80

Internal drawers / Cassetti interni / Innenschubladen

A3	-	FRK27C1	55 55 9.4	4	60 60 20	5	0.10
A4	-	FRK45C1	115 55 9.4	9	120 60 20	10	0.20

"Metal Design" finishes: 15% surcharge / Finiture "Metal Design": maggiorazione del 15% / "Metal Design"-Oberflächen: 15% Aufschlag

Optional packaging with wooden crate / Imballaggio opzionale con cassa in legno / Optionale Verpackung mit Holzkiste (260x90xH130) = € 900,00



Stoneware, glass or coated steel tops / Top in grès, vetro o acciaio verniciato / Arbeitsplatten aus Steinzeug, Glas oder lackierter Stahl

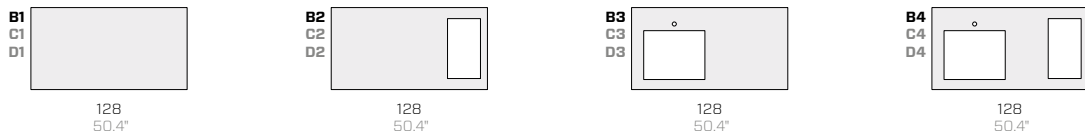

Steel top 12 mm, sink radius 10 mm / Top in acciaio 12 mm, vasca raggio 10 mm / Arbeitsplatte 12 mm, Beckenradius 10 mm

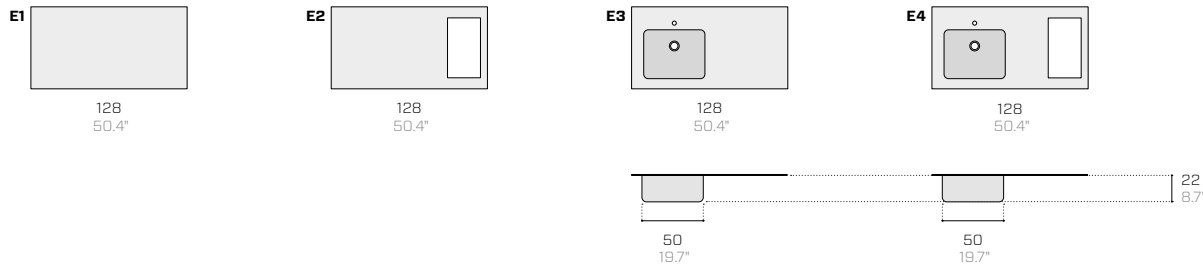

Steel top 4 mm, sink radius 0 mm / Top in acciaio 4 mm, vasca raggio 0 mm / Arbeitsplatte 4 mm, Beckenradius 0 mm

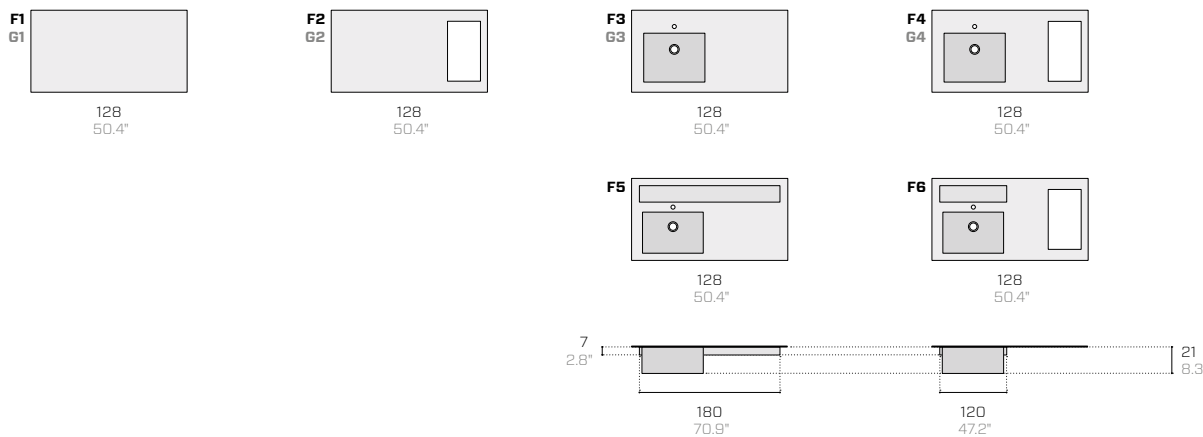

F5, F6: with SST equipment channel. Accessories on p. 62 / con canale attrezzato in inox. Accessori a pag. 62 / mit vorgerüstetem Abfluss aus Edelstahl. Zubehör auf S. 62

Useful measurements of the 4 mm SST top / Quote utili del top in inox 4 mm / Nützliche Maßen der 4 mm Edelstahlplatte

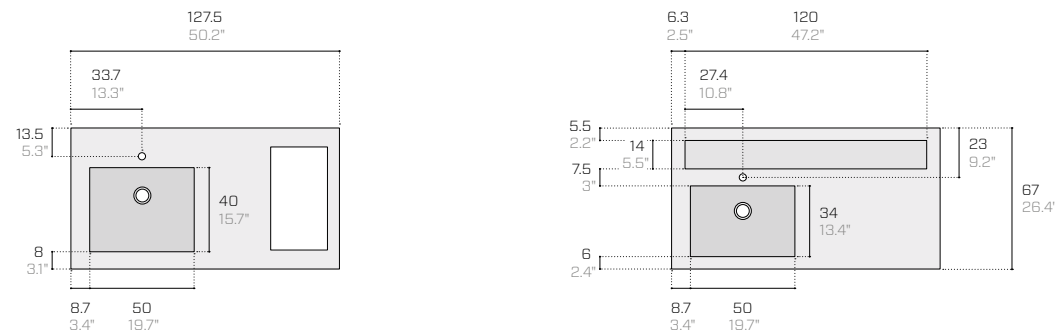

Product / Prodotto / Produkt

Packaging / Imballo / Verpackung

No.	Price	Code	Dimensions (w-d-h)	Weight	Dimensions (w-d-h)	Weight	Vol pkg
No.	Prezzo	Codice	Dimensioni (l-p-h)	Peso	Dimensioni (l-p-h)	Peso	Vol. collo
N°	Preis	Code	Abmessungen (b-t-h)	Gewicht	Abmessungen (b-t-h)	Gewicht	Vol. Kollo
				euro			mc
				cm			kg
				kg			cm

Porcelain stoneware top 12 mm / Top in grès porcellanato 12 mm / Arbeitsplatte aus Feinsteinzeug 12 mm

B1	-	FR88TOPS-GC	128 67 1.2	27	137 80 21	37	0.3
B2	-	FR88TC-GC	128 67 1.2	25	137 80 21	35	0.3
B3	-	FR88TV-GC	128 67 1.2	22.5	137 80 21	32.5	0.3
B4	-	FR88TVC-GC	128 67 1.2	21	137 80 21	31	0.3

Frosted painted glass top 6 mm / Top in vetro acidato e verniciato 6 mm / Satiniertes lackiertes Glas 6 mm

C1	-	FRV01A	128 67 0.6	12.5	143 82 12	19.5	0.2
C2	-	FRV03A	128 67 0.6	12	143 82 12	19	0.2
C3	-	FRV09A	128 67 0.6	12	143 82 12	19	0.2
C4	-	FRV10A	128 67 0.6	12.5	143 82 12	19.5	0.2

Coated stainless steel top 3 mm / Top in acciaio inox verniciato 3 mm / Beschichtete Edelstahlplatte 3 mm

C1	-	FR88T	128 67 0.3	18	137 80 21	26	0.3
C2	-	FR88TC	128 67 0.3	16	137 80 21	24	0.3
C3	-	FR88TV	128 67 0.3	13.5	137 80 21	21.5	0.3
C4	-	FR88TVC	128 67 0.3	12	137 80 21	20	0.3

Satin steel top 12 mm, sink radius 10 mm / Top in acciaio satinato 12 mm, vasca raggio 10 mm / Satinierte Arbeitsplatte 12 mm, Beckenradius 10 mm

E1	-	FRX231S	128 67 1.2	12.5	137 80 21	19.5	0.3
E2	-	FRX232S	128 67 1.2	11	137 80 21	18	0.3
E3	-	FRX233S	128 67 1.2	13.5	137 80 50	20.5	0.6
E4	-	FRX234S	128 67 1.2	11.5	137 80 50	18.5	0.6

Satin steel top 4 mm, sink radius 10 mm / Top in acciaio satinato 4 mm, vasca raggio 10 mm / Satinierte Arbeitsplatte 4 mm, Beckenradius 10 mm

F1	-	FRX201S	128 67 0.4	27	137 80 21	37	0.3
F2	-	FRX202S	128 67 0.4	23	137 80 21	33	0.3
F3	-	FRX203S	128 67 0.4	25	137 80 50	35	0.6
F4	-	FRX204S	128 67 0.4	22	137 80 50	32	0.6
F5	-	FRX239S	128 67 0.4	27	137 80 50	37	0.6
F6	-	FRX222S	128 67 0.4	25	137 80 50	35	0.6

Vintage steel top 4 mm, sink radius 0 mm / Top in acciaio Vintage 4 mm, vasca raggio 0 mm / Vintage Arbeitsplatte 4 mm, Beckenradius 0 mm

G1	-	FRB41V	128 67 0.4	27	137 80 21	37	0.3
G2	-	FRB43V	128 67 0.4	23	137 80 21	33	0.3
G3	-	FRB45V	128 67 0.4	25	137 80 50	35	0.6
G4	-	FRB46V	128 67 0.4	22	137 80 50	32	0.6

Additional top 64x67 cm: 30% surcharge / Top aggiuntivo 64x67 cm: maggiorazione del 30% / Zusätzliche Oberfläche 64x67 cm: 30% Aufschlag

Single top for configurations: contact sales / Top unico per configurazioni: contattare commerciale / Einteilige Arbeitsplatte für Konfigurationen: Vertrieb kontaktieren

"Metal Design" finishes: 15% surcharge / Finiture "Metal Design": maggiorazione del 15% / "Metal Design"-Oberflächen: 15% Aufschlag

Optional packaging with wooden crate / Imballaggio opzionale con cassa in legno / Optionale Verpackung mit Holzkiste (260x90xH130) = € 900,00

Stoneware, glass or coated steel tops / Top in grès, vetro o acciaio verniciato / Arbeitsplatten aus Steinzeug, Glas oder lackierter Stahl

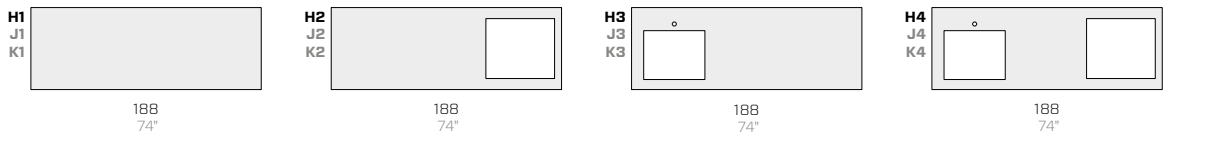

Steel top 12 mm, sink radius 10 mm / Top in acciaio 12 mm, vasca raggio 10 mm / Arbeitsplatte 12 mm, Beckenradius 10 mm

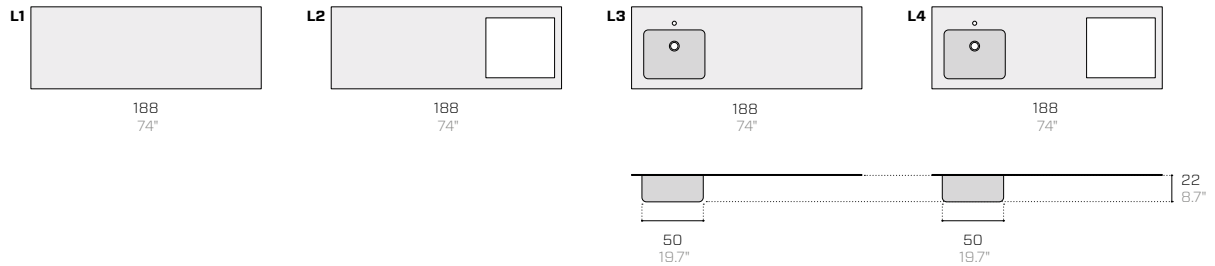

Steel top 4 mm, sink radius 0 mm / Top in acciaio 4 mm, vasca raggio 0 mm / Arbeitsplatte 4 mm, Beckenradius 0 mm

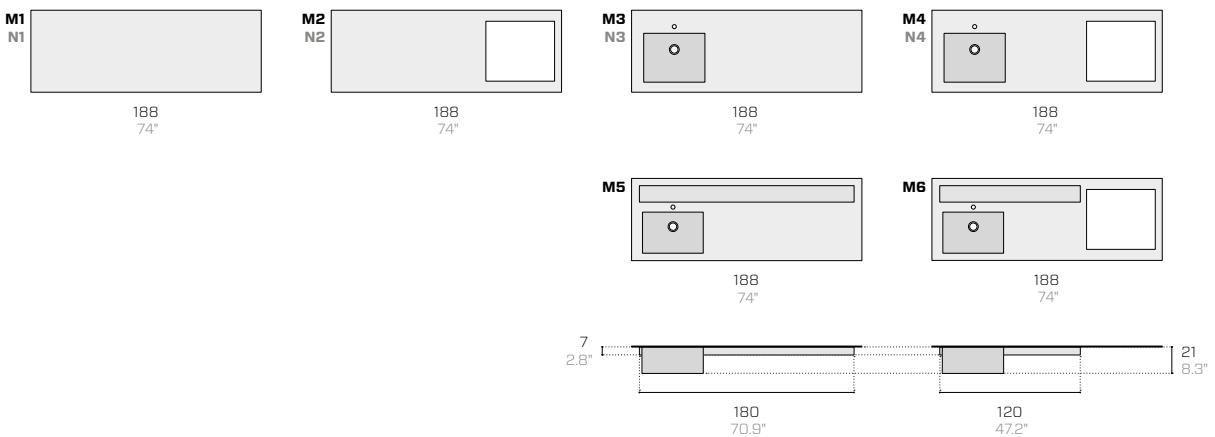

M5, M6, N5, N6: with SST equipment channel. Accessories on p. 62 / con canale attrezzato in inox. Accessori a pag. 62 / mit vorgerüstetem Abfluss aus Edelstahl. Zubehör auf S. 62

Useful measurements of the 4 mm SST top / Quote utili del top in inox 4 mm / Nützliche Maßen der 4 mm Edelstahlplatte

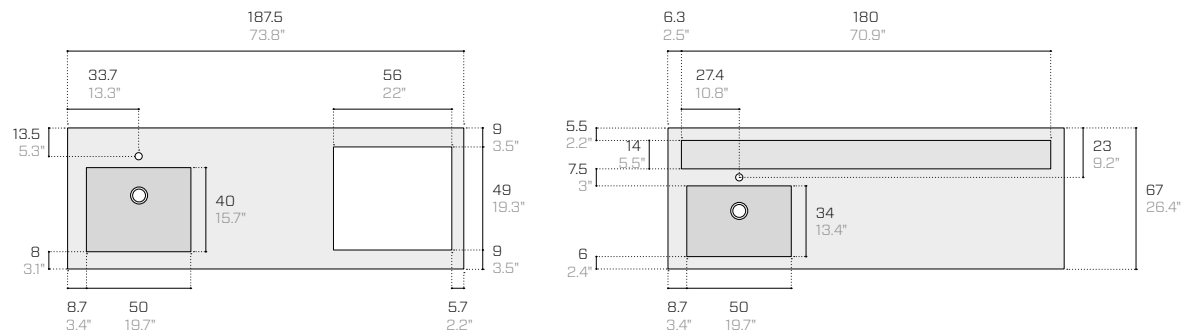

Product / Prodotto / Produkt

Packaging / Imballo / Verpackung

No.	Price	Code	Dimensions (w-d-h)	Weight	Dimensions (w-d-h)	Weight	Vol pkg
No.	Prezzo	Codice	Dimensioni (l-p-h)	Peso	Dimensioni (l-p-h)	Peso	Vol. collo
N°	Preis	Code	Abmessungen (b-t-h)	Gewicht	Abmessungen (b-t-h)	Gewicht	Vol. Kollo
				cm			mc
				kg			

Porcelain stoneware top 12 mm / Top in grès porcellanato 12 mm / Arbeitsplatte aus Feinsteinzeug 12 mm

H1	-	FR81TOPS-GC	188 67 1.2	40	203 82 12	10	0.2
H2	-	FR81TC-GC	188 67 1.2	36	203 82 12	10	0.2
H3	-	FR81TV-GC	188 67 1.2	35	203 82 12	10	0.2
H4	-	FR81TVC-GC	188 67 1.2	31	203 82 12	10	0.2

Frosted painted glass top 6 mm / Top in vetro acidato e verniciato 6 mm / Satiniertes lackiertes Glas 6 mm

J1	-	FRV05A	188 67 0.6	18.5	203 82 12	28.5	0.2
J2	-	FRV07A	188 67 0.6	18	203 82 12	28	0.2
J3	-	FRV11A	188 67 0.6	18	203 82 12	28	0.2
J4	-	FRV12A	188 67 0.6	18.5	203 82 12	28.5	0.2

Coated stainless steel top 3 mm / Top in acciaio inox verniciato 3 mm / Beschichtete Edelstahlplatte 3 mm

K1	-	FR81T	188 67 0.4	26	203 82 12	10	0.2
K2	-	FR81TC	188 67 0.4	22	203 82 12	10	0.2
K3	-	FR81TV	188 67 0.4	21	203 82 12	10	0.2
K4	-	FR81TVC	188 67 0.4	17	203 82 12	10	0.2

Satin steel top 12 mm, sink radius 10 mm / Top in acciaio satinato 12 mm, vasca raggio 10 mm / Satinierte Arbeitsplatte 12 mm, Beckenradius 10 mm

L1	-	FRX235S	188 67 1.2	18.5	197 80 21	28.5	0.4
L2	-	FRX236S	188 67 1.2	17	197 80 21	27	0.4
L3	-	FRX237S	188 67 1.2	19.5	197 80 50	29.5	0.8
L4	-	FRX238S	188 67 1.2	17.5	197 80 50	27.5	0.8

Satin steel top 4 mm, sink radius 10 mm / Top in acciaio satinato 4 mm, vasca raggio 10 mm / Satinierte Arbeitsplatte 4 mm, Beckenradius 10 mm

M1	-	FRX209S	188 67 0.4	40	197 80 21	50	0.4
M2	-	FRX210S	188 67 0.4	31	197 80 21	41	0.4
M3	-	FRX211S	188 67 0.4	38	197 80 50	48	0.8
M4	-	FRX212S	188 67 0.4	30	197 80 50	40	0.8
M5	-	FRX240S	188 67 0.4	39	197 80 50	49	0.8
M6	-	FRX241S	188 67 0.4	35	197 80 50	45	0.8

Vintage steel top 4 mm, sink radius 0 mm / Top in acciaio Vintage 4 mm, vasca raggio 0 mm / Vintage Arbeitsplatte 4 mm, Beckenradius 0 mm

N1	-	FRB71V	188 67 0.4	40	197 80 21	50	0.4
N2	-	FRB73V	188 67 0.4	31	197 80 21	41	0.4
N3	-	FRB75V	188 67 0.4	38	197 80 50	48	0.8
N4	-	FRB76V	188 67 0.4	30	197 80 50	40	0.8

Additional top 64x67 cm: 30% surcharge / Top aggiuntivo 64x67 cm: maggiorazione del 30% / Zusätzliche Oberfläche 64x67 cm: 30% Aufschlag

Single top max 376x134 cm: upon request / Top unico max 376x134 cm: su richiesta / Einteilige Arbeitsplatte max 376x134 cm: auf Anfrage

"Metal Design" finishes: 15% surcharge / Finiture "Metal Design": maggiorazione del 15% / "Metal Design"-Oberflächen: 15% Aufschlag

Optional packaging with wooden crate / Imballaggio opzionale con cassa in legno / Optionale Verpackung mit Holzkiste (260x90xH130) = € 900,00

Top thicknesses / Spessori dei top / Stärken der Arbeitsplatten

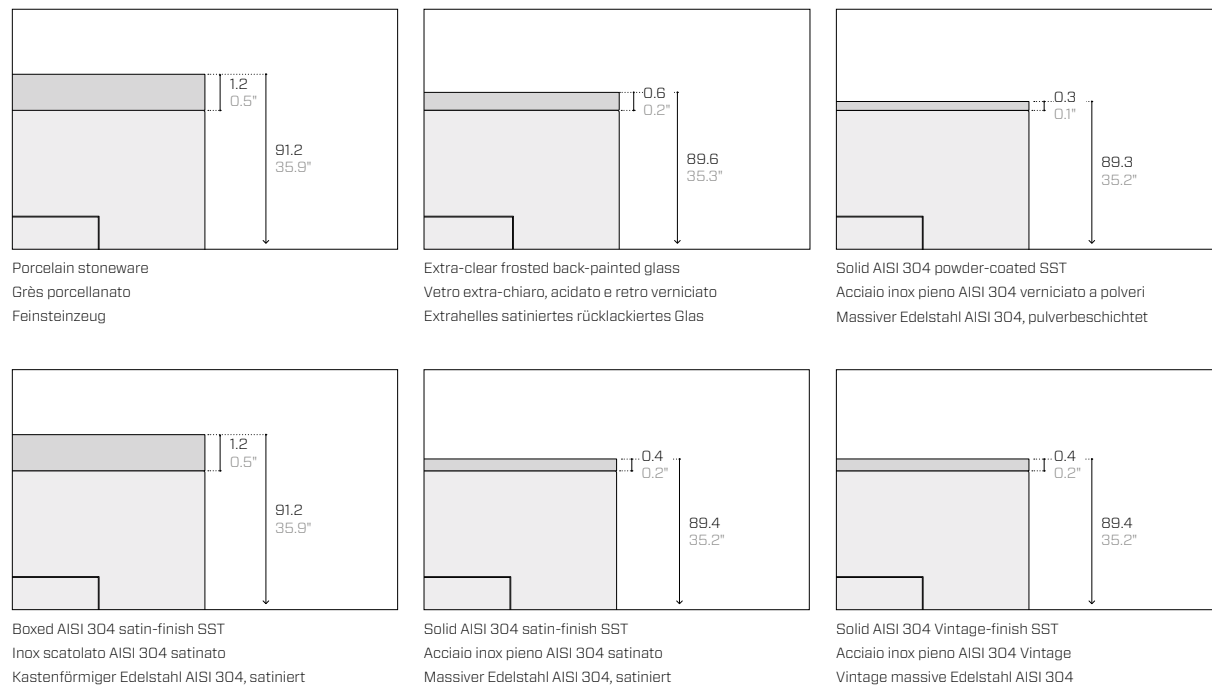

Other useful measurements / Altre quote utili / Andere nützliche Maßen

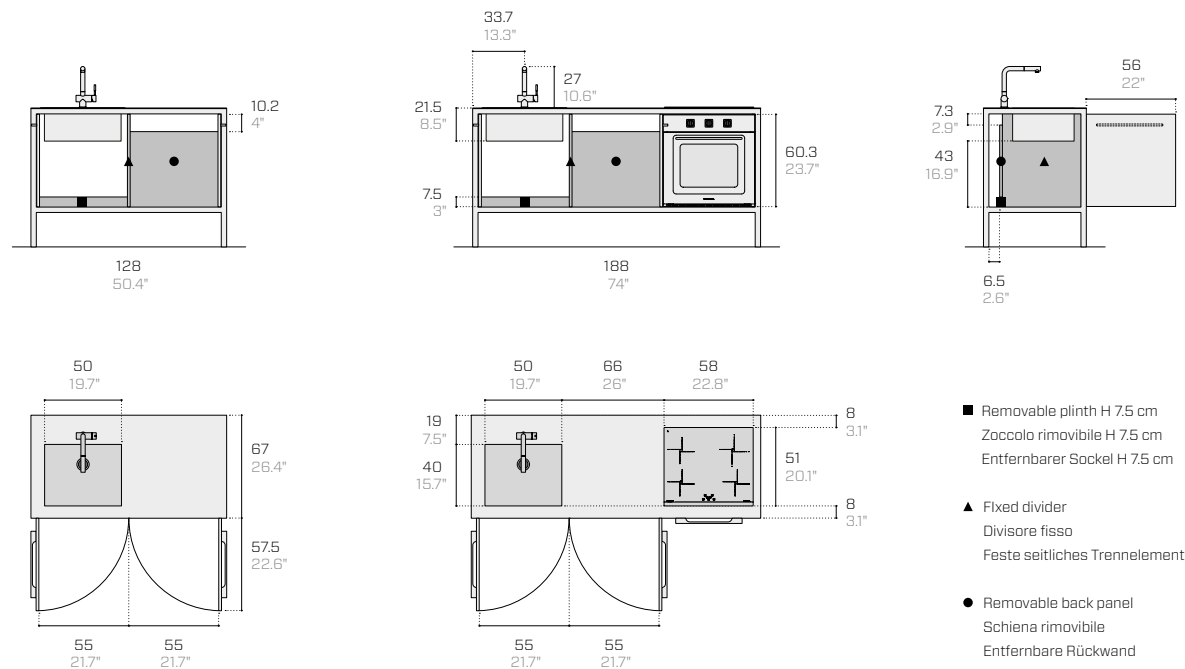

Accessories for tops / Accessori per top / Zubehör für Arbeitsplatten

Appliances and other accessories / Elettrodomestici e altri accessori / Haushaltsgeräte und anderes Zubehör



- Scan the QR code to get information on **appliances for tops** and **accessories for equipment channels**.
- Scansiona il QR-Code per ottenere informazioni su **elettrodomestici per top** e **accessori per canali attrezzati**.
- Über den QR-Code erhalten Sie Informationen zu **Geräte für Arbeitsplatten** und **Zubehör für Vorgerüstete Kanäle**.

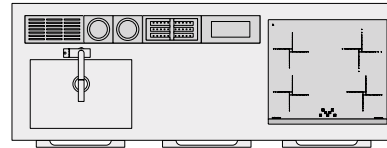

Equipment channels / Canali attrezzati / Vorgerüstete Kanäle

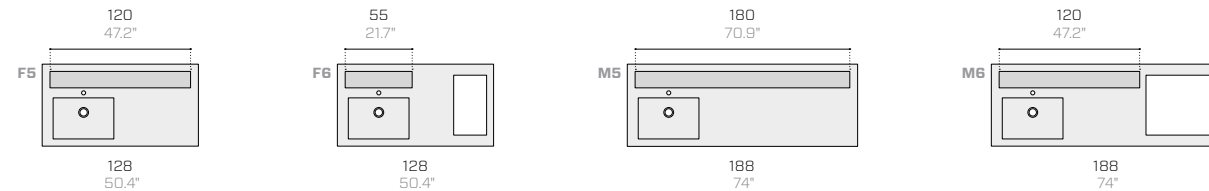

- The equipment channels (H 2.8") hold a selection of interchangeable accessories, some of which are shown below. Scan the QR code above to view the entire range. Channel and accessories in satin-finish AISI 304 stainless steel.
- Il canale attrezzato (H 7 cm) contiene accessori combinabili a scelta, alcuni dei quali sono illustrati qui sotto. Scansionando il QR-Code in alto è possibile accedere all'intera gamma. Canale e accessori in acciaio inox AISI 304 satinato.
- Der vorgerüstete Abfluss (H 7 cm) umfassen eine Auswahl kombinierbarer Zubehörteile, von denen einige unten dargestellt sind. Durch Scannen des QR-Codes oben können Sie auf das gesamte Sortiment zugreifen. Kanäle und Zubehör aus satiniertem Edelstahl AISI 304.

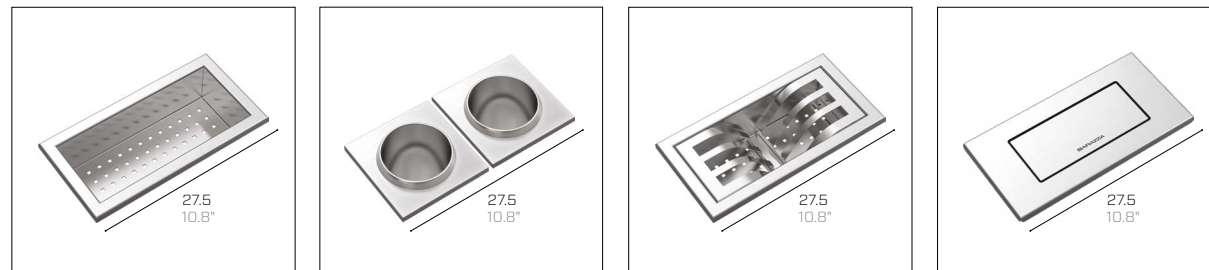

**Sink (H 7 cm)** / Vaschetta (H7 cm) / Wanne (H7 cm)  
**Bottle rack (H17 cm; 2 pieces)** / Portabottiglie (H17 cm; 2 elementi) / Flaschenhalter (H17 cm; 2 Elemente)  
**Dish drainer (H 7 cm)** / Scolapiatti (H 7 cm) / Abtropfgestell (H 7 cm)  
**Flip-up power outlet** / Portaprese basculante / Klappbare Steckdosenleiste



Product / Prodotto / Produkt

Packaging / Imballo / Verpackung

No. / No. / N°	Price / Prezzo / Preis	Code / Codice / Code	Dimensions (w-d-h) / Dimensioni (l-p-h) / Abmessungen (b-t-h)	Weight / Peso / Gewicht	Dimensions (w-d-h) / Dimensioni (l-p-h) / Abmessungen (b-t-h)	Weight / Peso / Gewicht	Vol pkg / Vol. collo / Vol. Kollo
			cm	kg	cm	kg	mc
			euro				

Overtop sink in satin stainless steel / Vasca sopratop in inox satinato / Überbaubecken in inox Satin

<b>P1</b>	-	<a href="#">FRB20S</a>	55.5 45.5 21.5	6.5	59.5 49.5 27	8.5	0.1
-----------	---	------------------------	----------------	-----	--------------	-----	-----

Tap without pull-out spray / Rubinetto senza doccino estraibile / Wasserhahn ohne ausziehbarer Brause

<b>P2</b>	-	<a href="#">FRB26S</a>	11 26 35	2.5	44 34 7	3.5	0.1
-----------	---	------------------------	----------	-----	---------	-----	-----

Taps with pull-out spray / Rubinetti con doccino estraibile / Wasserhähne mit ausziehbarer Brause

<b>P3</b>	-	<a href="#">FRB10C</a>	13 26 27	3	59 25 10	4	0.1
<b>P4</b>	-	<a href="#">FRB10N</a>	13 26 27	3	59 25 10	4	0.1
<b>P5</b>	-	<a href="#">FRB10S</a>	13 26 27	3	59 25 10	4	0.1
<b>P6</b>	-	<a href="#">FRB10V</a>	13 26 27	3	59 25 10	4	0.1

Roll-up draining mat / Griglia multiuso avvolgibile / Aufrollbare Abtropfmatte

<b>P7</b>	-	<a href="#">FRB11</a>	47 45 1	1	50 8 8	1	0.1
-----------	---	-----------------------	---------	---	--------	---	-----

Built-in dish drainer / Griglia scolapiatti a incasso / Einbau-Abtropfgitter

<b>P8</b>	-	<a href="#">FRB07</a>	55 26 17	3	60 30 20	4	0.1
-----------	---	-----------------------	----------	---	----------	---	-----

Other SST accessories for tops / Altri accessori in inox per top / Weitere Zubehör aus Edelstahl für Arbeitsplatten



Satin overtop sink / Vasca satinata sopratop / Satiniertes Überbaubecken

Tap without pull-out spray / Rubinetto senza doccino estraibile / Wasserhahn ohne ausziehbarer Brause

Taps with pull-out spray / Rubinetti con doccino estraibile / Wasserhähne mit ausziehbarer Brause



Hole size for the P1 sink / Foratura top per vasca P1 / Größe der Bohrungen für Beck P1

Roll-up draining mat / Griglia multiuso avvolgibile / Aufrollbare Abtropfmatte

Freestanding dish drainer / Griglia scolapiatti in appoggio / Aufliegendes Abtropfgitter

Accessories for internal compartments / Accessori per vani interni / Zubehör für Innenfächer

Built-in appliances / Elettrodomestici a incasso / Einbaugeräten



- Scan the QR code to get information on **built-in appliances**
- Scansiona il QR-Code per ottenere informazioni sugli **elettrodomestici a incasso**
- Über den QR-Code erhalten Sie Informationen zu **Einbaugeräte**

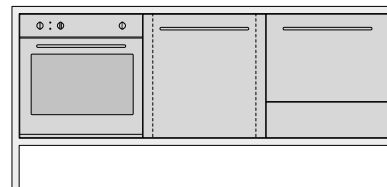

Cutlery dividers / Divisori portaposate / Besteckeinsätze

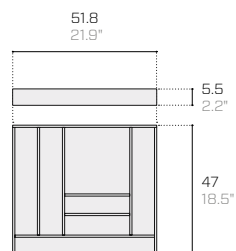

Waste separation kit / Kit contenitori differenziata / Mülltrennsystem

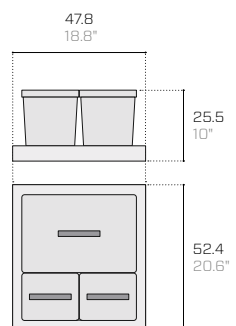
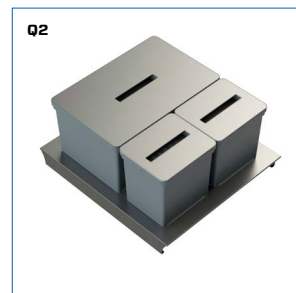

Additional shelves / Ripiani aggiuntivi / Zusätzliche Einlegeböden



Product / Prodotto / Produkt

Packaging / Imballo / Verpackung

No.	Price	Code	Dimensions (w-d-h)	Weight	Dimensions (w-d-h)	Weight	Vol pkg
No.	Prezzo	Codice	Dimensioni (l-p-h)	Peso	Dimensioni (l-p-h)	Peso	Vol. collo
N°	Preis	Code	Abmessungen (b-t-h)	Gewicht	Abmessungen (b-t-h)	Gewicht	Vol. Kollo
	euro		cm	kg	cm	kg	mc

Cutlery dividers / Divisori portaposate / Besteckeinsätze

<b>Q1</b>	-	<a href="#">FRK19DP</a>	47 52 6.5	0.8	60 20 10	1	0.1
-----------	---	-------------------------	-----------	-----	----------	---	-----

Waste separation kit / Kit contenitori differenziata / Mülltrennsystem

<b>Q2</b>	-	<a href="#">FRK64DIE</a>	47 52 25	3	53 50 30	4	0.1
-----------	---	--------------------------	----------	---	----------	---	-----

Additional shelves / Ripiani aggiuntivi / Zusätzliche Einlegeböden

<b>Q3</b>	-	<a href="#">FRK15R1</a>	56.5 46 2	2.5	50 10 6	2.6	0.1
-----------	---	-------------------------	-----------	-----	---------	-----	-----

"Metal Design" finishes: 15% surcharge / Finiture "Metal Design": maggiorazione del 15% / "Metal Design"-Oberflächen: 15% Aufschlag

Freestanding appliance kits / Kit per elettrodomestici a terra / Bausatz für die Bodenmontage von Haushaltsgeräten

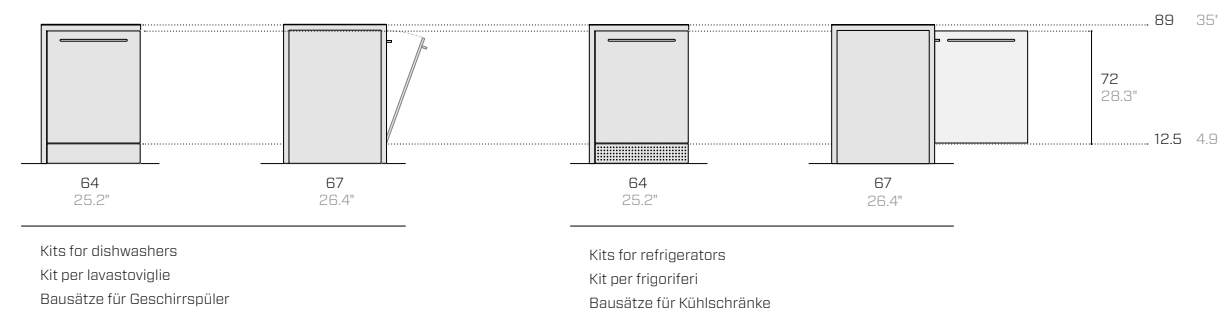

For more information, scan the QR code on the opposite page.

Per maggiori informazioni, scansiona il codice QR nella pagina a fianco.

Für weitere Informationen scannen Sie bitte den QR-Code auf der gegenüberliegenden Seite.

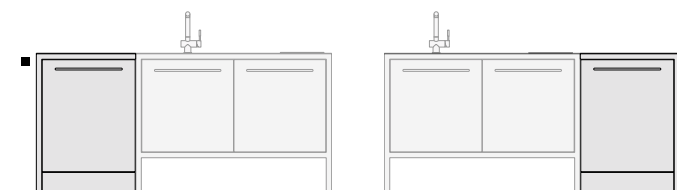

The kits can be placed on either the left [■] or the right [▲].  
Il kit è posizionabile sia a sinistra [■] sia a destra [▲].  
Der Bausatz kann sowohl links [■] als auch rechts [▲] positioniert werden.

Wall accessories / Accessori a parete / Wandzubehör

Backsplash matching top's finish / Alzatina in tinta con la finitura del top / Aufkantung in der gleichen Farbe wie die Arbeitsplatte

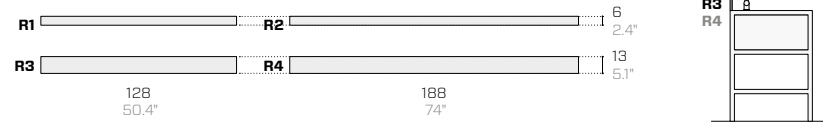

Shelf / Mensola / Regalbrett

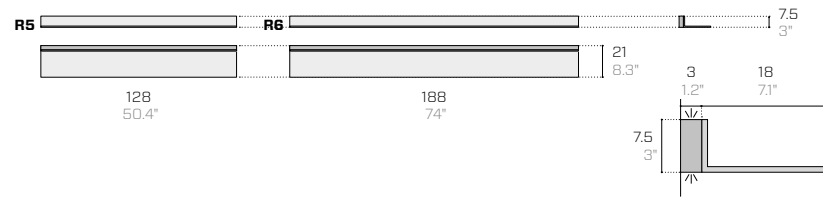

Open compartment / Vano a giorno / Offenes Fach

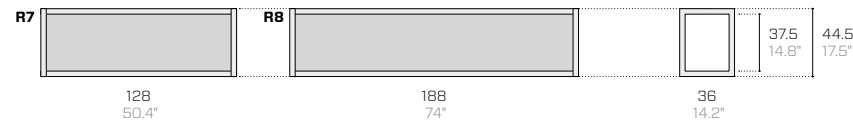

Perforated wall panel / Boiserie forate / Perforierte Wandpaneele

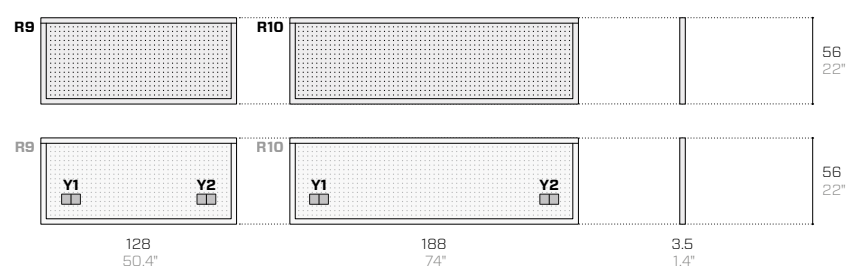

Perforated wall panel with shelf / Boiserie forate con mensola / Perforierte Wandpaneele mit Regal

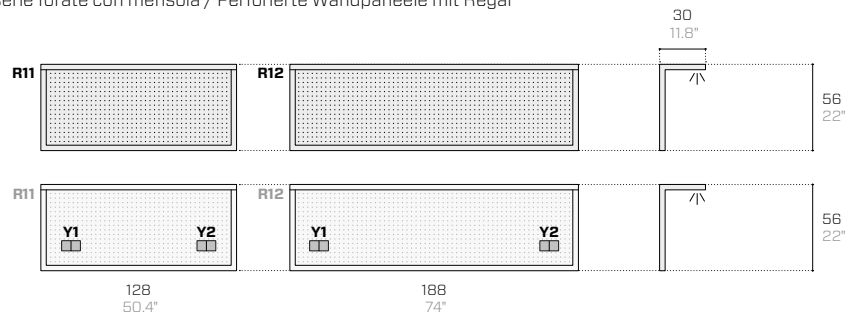

R11, R12: compatible with 3000K LED bar / compatibili con barra LED 3000K / kompatibel mit 3000K LED Bar

Product / Prodotto / Produkt

Packaging / Imballo / Verpackung

No. / No. / N°	Price / Prezzo / Preis	Code / Codice / Code	Dimensions (w-d-h) / Dimensioni (l-p-h) / Abmessungen (b-t-h)	Weight / Peso / Gewicht	Max capacity / Capacità max / Max. Tragfähigkeit	Dimensions (w-d-h) / Dimensioni (l-p-h) / Abmessungen (b-t-h)	Weight / Peso / Gewicht	Vol pkg / Vol. collo / Vol. Kollo
				cm	kg			
				cm	kg			

Backsplash matching top's finish / Alzatina in tinta con la finitura del top / Aufkantung in der gleichen Farbe wie die Arbeitsplatte

R1	-	FR000	128 - 6	-	-	137 5 10	3	0.1
R2	-	FR000	188 - 6	-	-	197 5 10	3	0.1
R3	-	FR000	128 - 13	-	-	137 5 10	3	0.1
R4	-	FR000	188 - 13	-	-	197 5 10	3	0.1

Shelf / Mensola / Regalbrett

R5	-	FRM15	128 21 7.5	8.5	12	140 30 20	9.5	0.1
R6	-	FRM17	188 21 7.5	13	18	200 30 20	14	0.2

Open compartment / Vano a giorno / Offenes Fach

R7	-	FRM11	128 36 44.5	30	30	140 40 10	32	0.1
R8	-	FRM12	188 36 44.5	45	45	200 40 10	47	0.1

Perforated wall panels / Boiserie forate / Perforierte Wandpaneele

R9	-	FRM09	128 3.5 56	13	-	140 60 10	16	0.1
R10	-	FRM10	188 3.5 56	19	-	200 60 10	22	0.2

Perforated wall panels with shelf / Boiserie forate con mensola / Perforierte Wandpaneele mit Regal

R11	-	FRM05	128 30 56	17	30	140 60 40	20	0.4
R12	-	FRM06	188 30 56	26	45	200 60 20	30	0.3

IP54 recessed socket with cover / Presa da incasso IP54 con coperchio / Einbau-Steckdose IP54 mit Abdeckung

Y1-Y2	-	FRK46P1	12.2 6.6 4.3	0.3	-	20 10 10	0.5	0.1
-------	---	---------	--------------	-----	---	----------	-----	-----

LED bar 3000K with power supply / Barra LED 3000K con alimentatore / LED-Leiste 3000K mit Netzteil

-	-	FRS128L3	121 3.5 3.5	0.2	-	124 6.5 6.5	0.2	0.1
-	-	FRS188L3	181 3.5 3.5	0.3	-	184 6.5 6.5	0.3	0.1

Magnetic dimmer switch / Interruttore dimmer magnetico / Magnetischer Dimmer

-	-	FRSK6D	2 7 2	0.2	-	5 10 5	0.3	0.1
---	---	--------	-------	-----	---	--------	-----	-----

"Metal Design" finishes: 15% surcharge / Finiture "Metal Design": maggiorazione del 15% / "Metal Design"-Oberflächen: 15% Aufschlag

- Scan the QR code to have access to the power system dimensions.
- Dal QR-Code è possibile visualizzare gli ingombri del sistema di elettrificazione.
- Über den QR-Code können Sie Zugang zu den Abmessungen des Stromversorgungssystem haben.



Accessories for freestanding kitchens / Accessori per cucine freestanding / Zubehör für freistehende Küchen

Backboards / Schiene / Rückwände

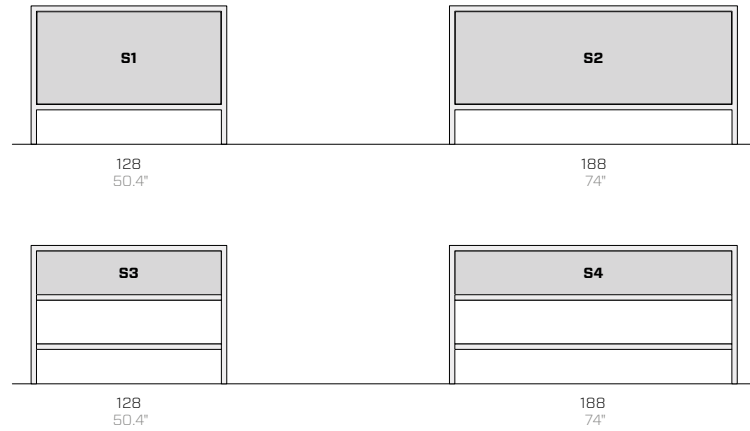

Attachment cover kit / Kit di copertura allacciamenti / Set für Abdeckung der Anschlüsse

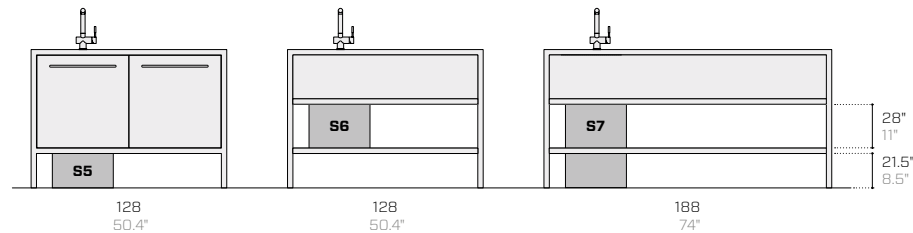

- Scan for information
- Scansiona per informazioni
- Scannen Sie nach Informationen

Wheel kit with colour-matching discs / Kit ruote con dischi in tinta / Radsatz mit farblich abgestimmten Scheiben

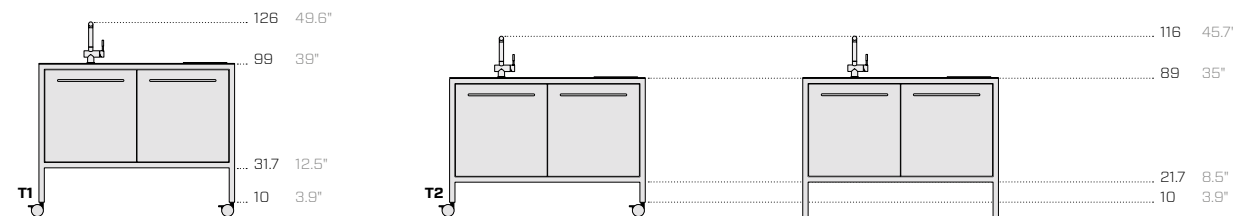

Kitchen height (with wheels)  
Altezza cucina (con ruote)  
Küchenhöhe (mit Rädern)

Kitchen with wheel kit and resized legs (same overall height as the kitchen without wheel kit)  
Cucina con kit ruote e gambe ridimensionate (stessa altezza complessiva della cucina senza kit ruote)  
Küche mit Radsatz und verkleinerte Beine (gleiche Gesamthöhe wie der Küche ohne Radsatz)

Product / Prodotto / Produkt

Packaging / Imballo / Verpackung

No.	Price	Code	Dimensions (w-d-h)	Weight	Dimensions (w-d-h)	Weight	Vol pkg
No.	Prezzo	Codice	Dimensioni (l-p-h)	Peso	Dimensioni (l-p-h)	Peso	Vol. collo
N°	Preis	Code	Abmessungen (b-t-h)	Gewicht	Abmessungen (b-t-h)	Gewicht	Vol. Kollo
			cm	kg	cm	kg	mc
			euro				

Backboards / Schiene / Rückwände

<b>S1</b>	—	FRK01S1	120 3 60	6	124 64 7	7	0.1
<b>S2</b>	—	FRK02S2	180 3 60	9	184 64 7	10	0.1
<b>S3</b>	—	FRK39S1	120 3 28	3	124 35 7	4	0.1
<b>S4</b>	—	FRK40S2	180 3 28	4.5	184 35 7	6	0.1

Attachment cover kit / Kit di copertura allacciamenti / Set für Abdeckung der Anschlüsse

<b>S5</b>	—	FRK03A1	40 20 21.5	3	43 23 24.5	5	0.1
<b>S6</b>	—	FRK41A1	40 20 28	4	43 23 31	5	0.1
<b>S7</b>	—	FRK44A1	40 20 49.5	7	43 23 52.5	10	0.1

Wheel kit with colour-matching discs / Kit ruote con dischi in tinta / Radsatz mit farblich abgestimmten Scheiben

<b>T1</b>	—	FRK31R8	8 3.5 10	2	20 10 10	2.5	0.1
<b>T2</b>	—	FRK33R8	8 3.5 10	2	20 10 10	2.5	0.1

“Metal Design” finishes: 15% surcharge / Finiture “Metal Design”: maggiorazione del 15% / “Metal Design“-Oberflächen: 15% Aufschlag

Top extension 23 cm: 30% surcharge / Allargamento top 23 cm: maggiorazione del 30% / Arbeitsplattenerweiterung 23 cm: 30% Aufschlag

Frame extension 23 cm: 15% surcharge / Allargamento telaio 23 cm: maggiorazione del 15% / Rahmenerweiterung 23 cm: 15% Aufschlag

Top extension / Allargamento top / Arbeitsplattenerweiterung

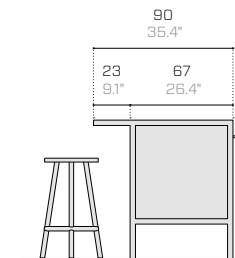

Cantilever top extension for all configurations, with welded frame  
Allargamento top a sbalzo per tutte le configurazioni, con telaio saldato  
Arbeitsplattenerweiterung in Ausführung als Überstand für alle Konfigurationen, mit geschweißtem Rahmen









**Metal Essentials**







 <p><b>01.18</b> <b>Black (RAL 9005)</b> Nero / Schwarz --- EM ▲</p>	 <p><b>08.20</b> <b>Rose quartz</b> Rosa quarzo / Rosenquarz --- EM ▲</p>	 <p><b>15.19</b> <b>Forest green (RAL 6007)</b> Verde bosco / Waldgrün --- EM ▲●</p>
 <p><b>02.18</b> <b>Anthracite (RAL 7021)</b> Antracite / Anthrazit --- EM ▲●</p>	 <p><b>09.24</b> <b>Terracotta (RAL 8004)</b> Terracotta / Terrakotta --- EM ▲●</p>	 <p><b>16.24</b> <b>Cement (RAL 7033)</b> Cemento / Zement --- EM ▲●</p>
 <p><b>03.18</b> <b>Fantin grey</b> Grigio Fantin / Fantin-Grau --- EM ▲●</p>	 <p><b>10.21</b> <b>Flame red (RAL 3000)</b> Rosso fuoco / Feuerrot --- EM ▲</p>	 <p><b>17.24</b> <b>Slate (RAL 7031)</b> Ardesia / Schiefer --- EM ▲●</p>
 <p><b>04.18</b> <b>Light grey (RAL 7035)</b> Grigio luce / Lichtgrau --- EM ▲●</p>	 <p><b>11.21</b> <b>Melon yellow (RAL 1028)</b> Giallo melone / Melonengelb --- EM ▲●</p>	 <p><b>18.21</b> <b>Dusty blue (RAL 5014)</b> Azzurro polvere / Staubiges blau --- EM ▲</p>
 <p><b>05.19</b> <b>Cloud grey</b> Grigio nuvola / Walkengrau --- EM ▲</p>	 <p><b>12.19</b> <b>Zinc yellow (RAL 1018)</b> Giallo zinco / Zinkgelb --- EM ▲</p>	 <p><b>19.18</b> <b>Gentian blue (RAL 5010)</b> Blu genziana / Enzianblau --- EM ▲●</p>
 <p><b>06.18</b> <b>White (RAL 9016)</b> Bianco / Weiß --- EM ▲</p>	 <p><b>13.21</b> <b>Pastel green (RAL 6019)</b> Verde pastello / Weißgrün --- EM ▲●</p>	 <p><b>20.19</b> <b>Steel blue (RAL 5011)</b> Blu acciaio / Stahlblau --- EM ▲</p>
 <p><b>07.21</b> <b>Milk white (RAL 9001)</b> Bianco latte / Milchweiß --- EM ▲●</p>	 <p><b>14.18</b> <b>Sage green (RAL 6021)</b> Verde salvia / Salbeigrün --- EM ▲●</p>	 <p><b>21.21</b> <b>Coffee brown (RAL 8019)</b> Marrone caffè / Kaffeebraun --- EM ▲</p>

**Metal Design**

**Metallic**

 <p><b>61.24</b> <b>Pale gold</b> Oro chiaro / Hellgold --- EM ▲</p>	 <p><b>62.24</b> <b>Copper</b> Rame / Kupfer --- EM ▲●</p>	 <p><b>47.21</b> <b>Platinum</b> Platino / Platin --- EM ▲</p>	 <p><b>43.21</b> <b>Bronze</b> Bronzo / Bronze --- EM ▲</p>	 <p><b>63.24</b> <b>Graphite</b> Grafite / Graphit --- EM ▲●</p>	 <p><b>64.24</b> <b>Silver green</b> Verde argento / Silbergrün --- EM ▲●</p>	 <p><b>65.24</b> <b>Silver blue</b> Blu argento / Silberblau --- EM ▲●</p>
---	---	---	---	---	--	---

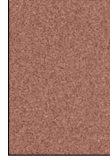
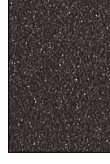
**Earth**

 <p><b>51.18</b> <b>Sand</b> Sabbia / Sand --- EM ▲●</p>	 <p><b>57.21</b> <b>Clay</b> Creta / Lehm --- EM ▲●</p>	 <p><b>52.18</b> <b>Moss</b> Muschio / Moos --- EM ▲●</p>	 <p><b>66.24</b> <b>Lichen</b> Lichene / Flechte --- EM ▲</p>	 <p><b>67.24</b> <b>Pink clay</b> Argilla rosa / Rosa Ton --- EM ▲●</p>	 <p><b>68.24</b> <b>Sodalite</b> Sodalite / Sodalith --- EM ▲</p>	 <p><b>56.21</b> <b>Ocean</b> Oceano / Ozean --- EM ▲</p>
---	--	--	---	--	--	--

For "Metal Design" finishes (Metallic, Earth), a 15% surcharge is applied. For orders with products of the same model in more than three different colours, Fantin reserves the possibility to evaluate a handling fee, discreetly according to order.

Per le finiture "Metal Design" (Metallic, Earth), è prevista una maggiorazione del 15%. Per ordini con prodotti dello stesso modello in più di tre colori, Fantin si riserva la possibilità di valutare un addebito per la gestione.

Für "Metal Design"-Oberflächen (Metallic, Earth) wird ein Aufschlag von 15% erhoben. Im Falle einer Bestellung mit Produkten desselben Modells in mehr als drei Farben, behält sich Fantin die Möglichkeit vor, einen Zuschlag für die Bearbeitung zu berechnen, mit Ermessensspielraum je nach Auftrag.

**Surfaces / Superfici / Oberflächen**

EM Embossed / Goffrato / Gaufriert













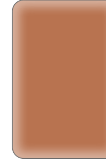

**Use / Utilizzo / Verwenden**

- ▲ Tops / Top / Arbeitsplatte
- Outdoor / Esterni / Außenbereich
- Food / Alimentare / Lebensmittel

Glass Essentials

 <b>G01.23</b> <b>Black (RAL 9005)</b> Nero / Schwarz --- ET ▲ ■	 <b>G08.23</b> <b>Rose quartz</b> Rosa quarzo / Rosenquarz --- ET ▲ ■	 <b>G15.23</b> <b>Forest green (RAL 6007)</b> Verde bosco / Waldgrün --- ET ▲ ■
 <b>G02.23</b> <b>Anthracite (RAL 7021)</b> Antracite / Anthrazit --- ET ▲ ■	 <b>G09.24</b> <b>Terracotta (RAL 8004)</b> Terracotta / Terrakotta --- ET ▲ ■	 <b>G16.24</b> <b>Cement (RAL 7033)</b> Cemento / Zement --- ET ▲ ■
 <b>G03.23</b> <b>Fantin grey</b> Grigio Fantin / Fantin-Grau --- ET ▲ ■	 <b>G10.23</b> <b>Flame red (RAL 3000)</b> Rosso fuoco / Feuerrot --- ET ▲ ■	 <b>G17.24</b> <b>Slate (RAL 7031)</b> Ardesia / Schiefer --- ET ▲ ■
 <b>G04.23</b> <b>Light grey (RAL 7035)</b> Grigio luce / Lichtgrau --- ET ▲ ■	 <b>G11.23</b> <b>Melon yellow (RAL 1028)</b> Giallo melone / Melonengelb --- ET ▲ ■	 <b>G18.23</b> <b>Dusty blue (RAL 5014)</b> Azzurro polvere / Staubiges blau --- ET ▲ ■
 <b>G05.23</b> <b>Cloud grey</b> Grigio nuvola / Wolkengrau --- ET ▲ ■	 <b>G12.23</b> <b>Zinc yellow (RAL 1018)</b> Giallo zinco / Zinkgelb --- ET ▲ ■	 <b>G19.23</b> <b>Gentian blue (RAL 5010)</b> Blu genziana / Enzianblau --- ET ▲ ■
 <b>G06.23</b> <b>White (RAL 9016)</b> Bianco / Weiß --- ET ▲ ■	 <b>G13.23</b> <b>Pastel green (RAL 6019)</b> Verde pastello / Weißgrün --- ET ▲ ■	 <b>G20.23</b> <b>Steel blue (RAL 5011)</b> Blu acciaio / Stahlblau --- ET ▲ ■
 <b>G07.23</b> <b>Milk white (RAL 9001)</b> Bianco latte / Milchweiß --- ET ▲ ■	 <b>G14.23</b> <b>Sage green (RAL 6021)</b> Verde salvia / Salbeigrün --- ET ▲ ■	 <b>G21.23</b> <b>Coffee brown (RAL 8019)</b> Marrone caffè / Kaffeebraun --- ET ▲ ■

Glass Design

 <b>G61.24</b> <b>Pale gold</b> Oro chiaro / Hellgold --- ET ▲ ■	 <b>G51.23</b> <b>Sand</b> Sabbia / Sand --- ET ▲ ■
 <b>G62.24</b> <b>Copper</b> Rame / Kupfer --- ET ▲ ■	 <b>G57.23</b> <b>Clay</b> Creta / Lehm --- ET ▲ ■
 <b>G47.23</b> <b>Platinum</b> Platino / Platin --- ET ▲ ■	 <b>G52.23</b> <b>Moss</b> Muschio / Moos --- ET ▲ ■
 <b>G43.23</b> <b>Bronze</b> Bronzo / Bronze --- ET ▲ ■	 <b>G66.24</b> <b>Lichen</b> Lichene / Flechte --- ET ▲ ■
 <b>G63.24</b> <b>Graphite</b> Grafite / Graphit --- ET ▲ ■	 <b>G67.24</b> <b>Pink clay</b> Argilla rosa / Rosa Ton --- ET ▲ ■
 <b>G64.24</b> <b>Silver green</b> Verde argento / Silbergrün --- ET ▲ ■	 <b>G68.24</b> <b>Sodalite</b> Sodalite / Sodalith --- ET ▲ ■
 <b>G65.24</b> <b>Silver blue</b> Blu argento / Silberblau --- ET ▲ ■	 <b>G56.23</b> <b>Ocean</b> Oceano / Ozean --- ET ▲ ■

For orders containing the same model of a product in more than three different colours, Fantin reserves the right to consider charging a handling fee.

Per ordini con prodotti dello stesso modello in più di tre colori, Fantin si riserva la possibilità di valutare un addebito per la gestione.

Bei Bestellungen von Produkten desselben Modells in mehr als drei verschiedenen Farben, behält sich Fantin die Möglichkeit vor, eine Bearbeitungsgebühr zu berechnen.

Surfaces / Superfici / Oberflächen

ET Etched / Acidato / Geätzt

Use / Utilizzo / Verwenden

- ▲ Tops / Top / Arbeitsplatte
- Outdoor / Esterni / Außenbereich
- Food / Alimentare / Lebensmittel

**Stainless steel**  
**Acciaio inox**  
**Edelstahl CNS**

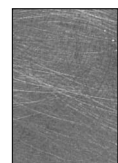

**K1.18**  
**Inox Vintage**  
Inox Vintage / Inox Vintage  
---  
**HG ▲●■**



**K2.19**  
**Inox Satin**  
Inox satinato / Inox satiniert  
---  
**HG ▲●■**

**Porcelain stoneware**  
**Gres porcellanato**  
**Feinsteinzeug**



**S1.26**  
**Dark**  
Scuro / Dunkel  
---  
**EM ▲●■**



**S2.26**  
**Ash**  
Cenero / Asche  
---  
**EM ▲●■**



**S3.26**  
**Light**  
Chiaro / Hell  
---  
**EM ▲●■**

**Melamine coated**  
**Nobilitato**  
**Melaminbeschichtet**



**M3.21**  
**Black**  
Nero / Schwarz  
---  
**EM ▲**



**M1.18**  
**Grey**  
Grigio / Grau  
---  
**EM ▲**



**M2.18**  
**White**  
Bianco / Weiß  
---  
**EM ▲**

**Fabric**  
**Tessuto**  
**Textil**



**T1.26**  
**Smoke**  
Fumo / Rauch



**T4.26**  
**Amber**  
Ambra / Bernstein



**T7.26**  
**Taupe**  
Tortora / Taupe



**T2.26**  
**Hemp**  
Canapa / Hanf

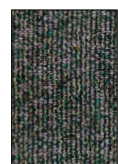

**T5.26**  
**Leaf**  
Foglia / Blatt

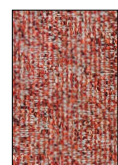

**T3.26**  
**Oxide**  
Ossido / Oxid

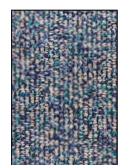

**T6.26**  
**Navy**  
Navy / Marine

**Surfaces / Superfici / Oberflächen**

**EM** Embossed / Goffrato / Gaufrirt  
**HG** High Gloss / Lucido / Glänzend

**Use / Utilizzo / Verwenden**

- ▲ Tops / Top / Arbeitsplatte
- Outdoor / Esterni / Außenbereich
- Food / Alimentare / Lebensmittel

**Technical information**

**Metal** Non-toxic powder coating for interior use, with no heavy metals. Cured in an oven at 190 °C, following degreasing and phosphating. Guaranteed minimum thickness of 50 microns. Minimum resistance to salt spray of 200 hours (in accordance with the ASTM B117 standard). Some finishes are suitable for direct contact with food as required by Italian Law Decree D.M. 21/03/73. Requests for other RAL finishes can be considered. On some finishes, any partial discoloration following rubbing and/or abrasion has absolutely no effect on the technical, appearance/colour and chemical/physical characteristics of the product. This phenomenon tends to diminish over the useful life of the product and does not in any case present a health hazard to users.

**Glass** Extra-clear glass, thickness 6 mm (0.24"), acid-etched on the upper surface, ground with a smooth edge. Back-painted with water-based coatings in the 35 Fantin finishes.

**Stainless steel** Tops in AISI 304 stainless steel for indoor use and AISI 316 for outdoor use. Satin or Vintage finish (manual processing).

**Porcelain stoneware** Full-body porcelain stoneware tops, thickness 12 mm (0.47"), highly resistant to impacts, scratches, chemicals and high temperatures, suitable for indoor and outdoor use.

**Melamine-faced panel** Top with a wood-fibre panel core finished with melamine coatings. Other melamine finishes available on request.

**Fabric** Upholstery in technical fabric for furniture, made with 100% regenerated yarns certified GRS (Global Recycled Standard), wear-resistant and easy to maintain, suitable for indoor use.

**Informazioni tecniche**

**Metallo** Verniciatura per interni a polveri atossiche prive di metalli pesanti, con passaggio in forno a 190 °C, previo trattamento di sgrassaggio e fosfatazione. Spessore minimo garantito 50 micron, resistenza minima in nebbia salina pari a 200 ore (norma ASTM B117). Alcune finiture sono idonee al contatto diretto con alimenti come previsto dal decreto italiano D.M. 21/03/73. Altre finiture RAL valutabili su richiesta. Su alcune finiture, l'eventuale parziale cessione di colore in seguito a strofinamento e/o abrasione non influisce assolutamente sulle caratteristiche tecniche, di aspetto/colore, e chimico-fisiche del prodotto. Tale fenomeno tende a diminuire nel corso della vita utile del manufatto e non comporta in alcun caso pericoli per la salute degli utilizzatori.

**Vetro** Vetro extra-chiaro di spessore 6 mm (0.24"), acidato superiormente, molato con bordo filo-opaco. Retroverniciato con verniciatura all'acqua nelle 35 finiture Fantin.

**Acciaio inox** Piani in acciaio inox AISI 304 per uso indoor e AISI 316 per uso outdoor. Finitura satinata o Vintage (lavorazione manuale).

**Grès porcellanato** Piani in grès porcellanato a tutta massa, spessore 12 mm (0.47"), ad elevata resistenza a urti, graffi, agenti chimici e alte temperature, idonei per utilizzo indoor e outdoor.

**Nobilitato** Piano con struttura in pannello di fibre di legno rivestito con finiture melaminiche. Altre finiture melaminiche disponibili su richiesta.

**Tessuto** Rivestimento in tessuto tecnico per arredo, realizzato con filati 100% rigenerati certificati GRS (Global Recycled Standard), resistente all'usura e di facile manutenzione, idoneo per utilizzo indoor.

**Technische Informationen**

**Metall** Die Pulverbeschichtung der gift- und schwermetallfreien Pulverlacke für Innenbereiche erfolgt im Lackierofen bei 190 °C nach vorheriger Entfettung und Phosphatierung. Die garantierte Mindeststärke der Lackschicht beträgt 50 Mikron bei einer Mindestprüfungsdauer von 200 Stunden im Salznebel (ASTM-Norm B117). Einige Oberflächen sind für den direkten Kontakt mit Lebensmitteln geeignet, wie in der Verordnung vorgesehen Italienischer D.M. 21/03/73. Auf Anfrage können andere RAL- Finishes in Betracht gezogen werden. Bei einigen Ausführungen hat eine teilweise Verfärbung durch Reiben und/oder Abrieb keine Auswirkungen auf die technischen, optischen/farblichen und chemisch-physikalischen Eigenschaften des Produkts. Dieses Phänomen nimmt im Laufe der Nutzungsdauer des Produkts tendenziell ab und stellt in keinem Fall eine Gefahr für die Gesundheit der Benutzer dar.

**Glas** Extraklares Glas, Stärke 6 mm (0.24"), oberseitig geätzt, mit geschliffener, glatter Kante. Rückseitig lackiert mit wasserbasiereten Beschichtungen in den 35 Fantin-Oberflächen.

**Edelstahl** Arbeitsplatten aus Edelstahl AISI 304 für den Innenbereich und AISI 316 für den Außenbereich. Satiniert oder Vintage-Oberfläche (manuelle Bearbeitung).

**Feinsteinzeug** Arbeitsplatten aus durchgefärbtem Feinsteinzeug, Stärke 12 mm (0.47"), hohe Beständigkeit gegen Stöße, Kratzer, Chemikalien und hohe Temperaturen, geeignet für Innen- und Außenbereiche.

**Melaminbeschichtete Platte** Platte mit Kern aus Holzfasern und melaminbeschichteter Oberfläche. Weitere melaminbeschichtete Oberflächen auf Anfrage erhältlich.

**Textil** Bezug aus technischem Möbelstoff, hergestellt aus 100% regenerierten Garnen, GRS-zertifiziert (Global Recycled Standard), verschleißfest und pflegeleicht, geeignet für den Innenbereich.

**Sample box / Box campionari / Musterbox**

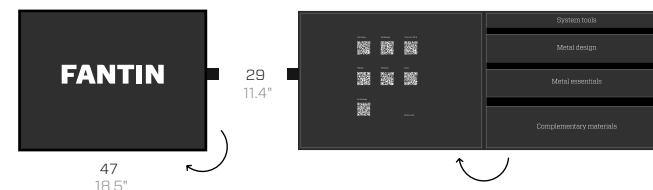

- Scan for information
- Scansiona per informazioni
- Scannen Sie nach Informationen

---

**Disclaimer / Esclusione di responsabilità / Haftungsausschluss**

Fantin Srl reserves the right to change the dimensions and features of the products contained in this technical data sheet at any time and without prior notice. The finishes illustrated are purely indicative as the accuracy tolerances of printing processes should be taken into account.

Fantin Srl si riserva la facoltà di modificare in qualsiasi momento e senza preavviso le dimensioni e l'esecuzione dei prodotti contenuti nella presente scheda tecnica. Le finiture riportate hanno valore indicativo in quanto soggette alle tolleranze dei processi di stampa.

Fantin Srl behält sich das Recht vor, die angegebenen Maße und Ausführungen der Produkte, welche dieses Produktblatt enthält, jederzeit ohne Vorankündigung zu ändern. Aufgrund drucktechnischer Abweichungen dienen die dargestellten Ausführungen nur der Illustration.

---

**Fantin Srl**

via San Vito, 43  
33080 - Bannia  
di Fiume Veneto (PN)  
Italia

t +39 0434 959 133  
f +39 0434 560 037  
fantin@fantin.com  
www.fantin.com

