

Frame Outdoor

Kitchens & workbenches

Salvatore Indriolo, 2018–2026



archiproducts
AWARDS
WINNER

archiproducts
AWARDS
WINNER
SUSTAINABILITY



Frame kitchens and workbenches are entirely made of AISI 316 stainless steel, suitable for outdoor use.

Frame in AISI 316 stainless steel, in 35 x 35 mm (1.38" x 1.38") square tube. Concealed adjustable feet.

Top in AISI 316 stainless steel, boxed construction, 6 mm thick with satin or Vintage finish (exclusive Barazza manual processing). Alternatively, available with porcelain stoneware top 12 mm thick or AISI 316 stainless steel top 3 mm thick, powder-coated to match the frame.

Doors inset in the frame, in bent sheet AISI 316 stainless steel, thickness 2 mm. Metal handles powder-coated to match the doors. Soft-close stainless steel hinges. 95° door opening.

Full-length flap door in AISI 316 stainless steel sheet, 2 mm thick, with soft-close stainless steel hinges.

Sides and bases inset in the frame, in bent sheet stainless steel.

Optional back panels in metal, inset in the frame.

Optional accessories: overtop sink; connection covers; wheel kit with discs matching the frame; internal shelves in bent sheet stainless steel.

Protective cover supplied for modules 128 and 188 (for multi-module compositions, please contact the sales office).

Surfaces should be cleaned and dried regularly following the use and maintenance instructions (see warranty at art. 7 in the terms and conditions of sale).

Kitchens are supplied assembled (top excluded).

Cucine e banconi del programma Frame sono realizzati interamente in acciaio inox AISI 316, idoneo per utilizzo in ambienti esterni.

Telaio in acciaio inox AISI 316 in tubolare quadrato 35 x 35 mm (1.38" x 1.38"). Piedini invisibili regolabili.

Top in acciaio inox AISI 316 con struttura scatolata spessore 6 mm, con finitura satinata o Vintage (lavorazione manuale esclusiva Barazza). In alternativa, disponibile top in grès porcellanato di spessore 12 mm oppure in acciaio inox AISI 316 di spessore 3 mm verniciato a polveri in tinta con il telaio.

Ante in luce al telaio, in lamiera piegata di acciaio inox AISI 316. Spessore 2 mm. Maniglie in metallo verniciate in tinta con le ante. Cerniere in acciaio inox ammortizzate. Apertura ante di 95°.

Ante a ribalta a tutta lunghezza in lamiera di acciaio inox AISI 316 spessore 2 mm, con cerniere in acciaio inox ammortizzate.

Fianchi e fondi in luce al telaio, realizzati in lamiera piegata di acciaio inox AISI 316.

Schiene opzionali in acciaio inox AISI 316 in luce al telaio.

Accessori opzionali: vasca sopra-top; coperture allacciamenti; kit ruote con dischi in tinta con il telaio; ripiani interni in lamiera piegata.

Fodera protettiva in dotazione per moduli da 128 e 188 (per composizioni con più moduli, contattare l'ufficio commerciale).

Si consiglia di pulire e asciugare regolarmente le superfici seguendo le prescrizioni di uso e manutenzione (garanzia all'art. 7 nelle condizioni di vendita).

Le cucine vengono fornite montate (top escluso).

Frame Outdoor - Kitchens & workbenches

Küchen und Werkbänke des Programms Frame bestehen vollständig aus Edelstahl AISI 316, geeignet für den Einsatz im Außenbereich.

Gestell aus Edelstahl AISI 316, aus Vierkantrohr 35 x 35 mm (1.38" x 1.38"). Unsichtbare, verstellbare Füße.

Arbeitsplatte aus Edelstahl AISI 316, 6 mm stark, in gefalteter Konstruktion, mit Satin- oder Vintage-Finish (exklusive manuelle Verarbeitung Barazza). Alternativ verfügbar mit Feinsteinzeug-Arbeitsplatte, 12 mm stark, oder Arbeitsplatte aus Edelstahl AISI 316, 3 mm stark, pulverbeschichtet in Rahmenfarbe.

Türen bündig im Gestell, aus gekantetem Edelstahl AISI 316, Stärke 2 mm. Metallgriffe pulverbeschichtet in Türfarbe. Gedämpfte Edelstahlscharniere. Türöffnung 95°.

Durchgehende Klapptür aus Edelstahl AISI 316, 2 mm stark, mit gedämpften Edelstahlscharnieren.

Seiten und Basen bündig im Gestell, aus gekantetem Edelstahlblech.

Optionale Rückwände aus Metall, bündig im Gestell.

Optionales Zubehör: Aufsatzspüle; Anschlussabdeckungen; Radsatz mit farblich abgestimmten Scheiben; Innenböden aus gekantetem Edelstahlblech.

Schutzhülle im Lieferumfang für Module 128 und 188 (für Mehrmodul-Kombinationen wenden Sie sich bitte an den Vertrieb).

Oberflächen regelmäßig reinigen und trocknen gemäß den Pflege- und Wartungshinweisen (Garantie siehe Art. 7 der Verkaufsbedingungen).

Küchen werden montiert geliefert (Arbeitsplatte ausgenommen).

Bases / Basi / Basen

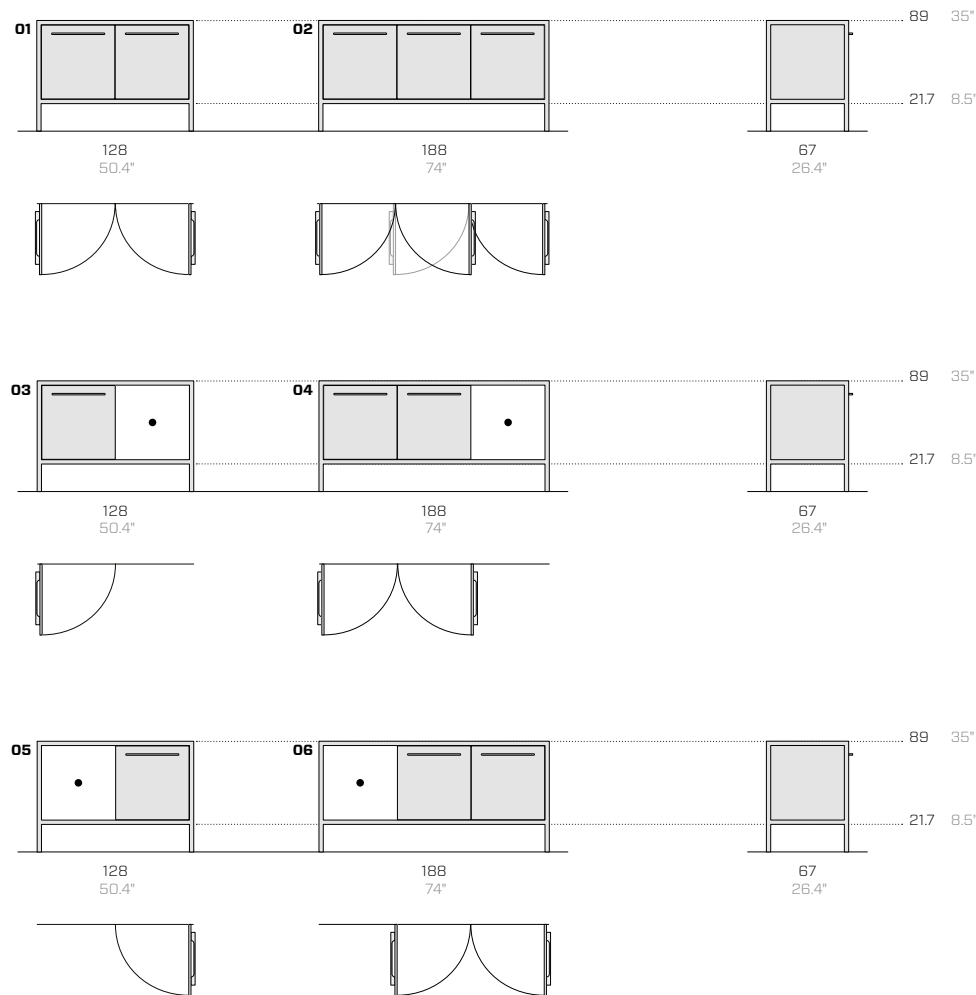

Compartment for appliances (see QR code p. XXX) / Vano per elettrodomestici (vedi QR code p. XXX) / Fach für Elektrogeräte (siehe QR-Code S. XXX)

Storage module on wheels / Modulo su ruote per contenimento / Modul auf Rädern für Stauraum

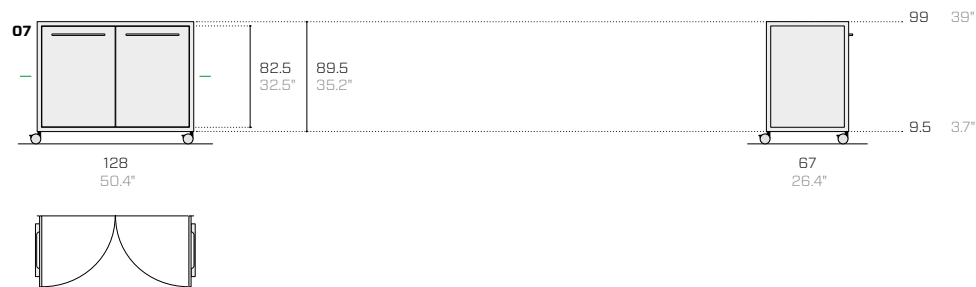

One shelf included, W 120 cm, height-adjustable / Un ripiano in dotazione L 120 cm, regolabile in altezza / Ein Fachboden im Lieferumfang, B 120 cm, höhenverstellbar

Product / Prodotto / Produkt

No.	Price	Code	Dimensions (w-d-h)	Weight	Dimensions (w-d-h)	Weight	Vol pkg
No.	Prezzo	Codice	Dimensioni (l-p-h)	Peso	Dimensioni (l-p-h)	Peso	Vol. collo
N°	Preis	Code	Abmessungen (b-t-h)	Gewicht	Abmessungen (b-t-h)	Gewicht	Vol. Kollo
	euro		cm	kg	cm	kg	mc

Bases / Basi / Basen

01	-	FR201AA-316	128 67 89	59	150 80 107	91	1.3
02	-	FR301AAA-316	188 67 89	66	200 80 107	109	1.8
03	-	FR202AV-316	128 67 89	52	150 80 107	84	1.3
04	-	FR302AAV-316	188 67 89	59	200 80 107	102	1.8
05	-	FR207VA-316	128 67 89	52	150 80 107	84	1.3
06	-	FR337VAA-316	188 67 89	59	200 80 107	102	1.8

Storage module on wheels / Modulo su ruote per contenimento / Modul auf Rädern für Stauraum

07	-	FR601AA-R-316	128 67 99.5	63	150 80 142	95	1.8
----	---	---------------	-------------	----	------------	----	-----

Appliance module on wheels / Modulo su ruote per elettrodomestici / Modul auf Rädern für Elektrogeräte

08	-	FR602FA-R-316	128 67 99.5	63	150 80 142	95	1.8
09	-	FR603LA-R-316	128 67 99.5	63	150 80 142	95	1.8
10	-	FR604FL-R-316	128 67 99.5	63	150 80 142	95	1.8
11	-	FR605AF-R-316	128 67 99.5	63	150 80 142	95	1.8
12	-	FR606AL-R-316	128 67 99.5	63	150 80 142	95	1.8
13	-	FR607LF-R-316	128 67 99.5	63	150 80 142	95	1.8

Additional shelf / Ripiano aggiuntivo / Zusätzlicher Einlegeboden

-	-	FRK36R-316	56.5 46 2	2.5	60 50 6	2.6	0.1
-	-	FRK43R-316	116.5 46 2	5	120 50 6	6	0.1

"Metal Design" finishes: 15% surcharge / Finiture "Metal Design": maggiorazione del 15% / "Metal Design"-Oberflächen: 15% Aufschlag

Shipping with wooden crate / Spedizione con cassa in legno / Versand mit Holzkiste (160x90xH130) = € 900,00

Appliance module on wheels / Modulo su ruote per elettrodomestici / Modul auf Rädern für Elektrogeräte

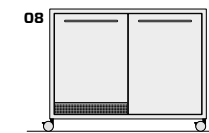

For refrigerator and pantry
Per frigorifero e dispensa
Für Kühlschrank und Speisekammer

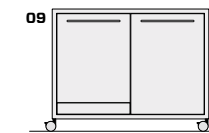

For dishwasher and pantry
Per lavastoviglie e dispensa
Für Geschirrspüler und Speisekammer

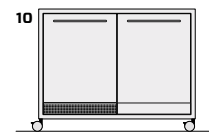

For refrigerator and for dishwasher
Per frigorifero e per lavastoviglie
Für Kühlschrank und für Geschirrspüler

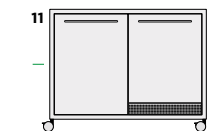

Pantry and for refrigerator
Dispensa e per frigorifero
Speisekammer und für Kühlschrank

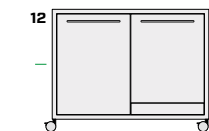

Pantry and for dishwasher
Dispensa e per lavastoviglie
Speisekammer und für Geschirrspüler

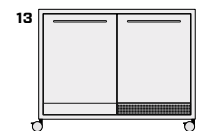

For dishwasher and for refrigerator
Per lavastoviglie e per frigorifero
Für Geschirrspüler und für Kühlschrank

One shelf included, W 60 cm, height-adjustable / Un ripiano in dotazione L 60 cm, regolabile in altezza / Ein Fachboden im Lieferumfang, B 60 cm, höhenverstellbar

Workbenches with open or closed shelves / Banconi con ripiani liberi o tamponati / Werkbänke mit offenen oder geschlossenen Regalen

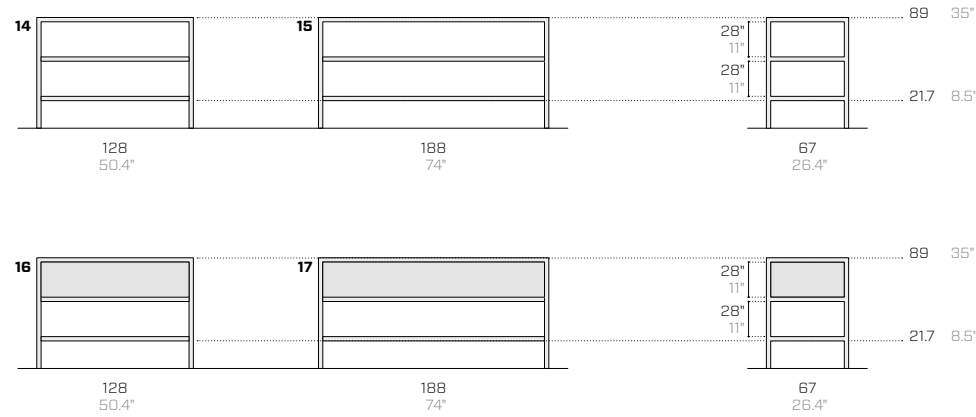

16, 17

Includes closed front and side panels (not opening; excludes back panel). For back panels and connection cover kits, see p. 228
 Include fronte e fianchi tamponati non apribili (schiena esclusa). Per schiene e kit di copertura allacciamenti, vedi a p. 228
 Inklusive geschlossene Front und Seiten (nicht öffnend; Rückwand ausgeschlossen). Für Rückwände und Anschlussabdeckungen siehe S. 228

Low workbenches with open shelves / Banconi ribassati con ripiani liberi/ Niedrige Werkbänke mit offenen Regalen



18

All L98 tops have the same prices as the corresponding L128 tops shown on p. 222.
 Tutti i top L98 hanno gli stessi prezzi dei rispettivi top L128 presenti a p. 222.
 Alle L98-Abdeckplatten haben dieselben Preise wie die entsprechenden L128-Abdeckplatten auf S. 222.

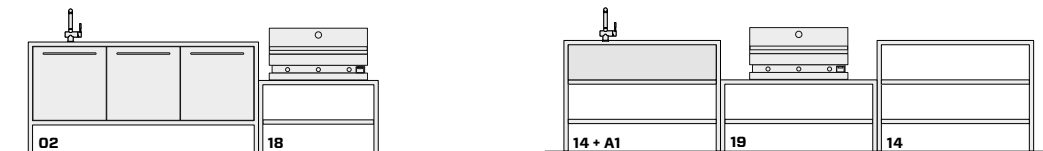

Product / Prodotto / Produkt

No. No. N°	Price Prezzo Preis	Code Codice Code	Dimensions (w-d-h)		Weight Peso Gewicht	Packaging / Imballo / Verpackung	
			Dimensions (l-p-h)	Abmessungen (b-t-h)		Dimensions (w-d-h)	Weight
			cm	kg	cm	kg	mc

Workbenches with open or closed shelves / Banconi con ripiani liberi o tamponati / Werkbänke mit offenen oder geschlossenen Regalen

14	-	FR621-316	128	67	89	56	150	80	107	99	1.3
15	-	FR622-316	188	67	89	75	200	80	107	118	1.8
16	-	FR611-316	128	67	89	60	150	80	107	103	1.3
17	-	FR612-316	188	67	89	80	200	80	107	123	1.8

Low workbenches with open shelves / Banconi ribassati con ripiani liberi/ Niedrige Werkbänke mit offenen Regalen

18	-	FR613-316	98	67	57	36	120	80	75	79	0.8
19	-	FR614-316	128	67	57	40	150	80	75	83	0.9

Full-length drop-down door (surcharge) / Anta a ribalta a tutta lunghezza (sovrapprezzo) / Türklappe über die gesamte Länge (Zuschlag)

A1	-	FRK34AR-316	120	2	28	7.5	130	10	40	10.5	0.1
A2	-	FRK35AR-316	180	2	28	11	190	10	40	14.5	0.1

"Metal Design" finishes: 15% surcharge / Finiture "Metal Design": maggiorazione del 15% / "Metal Design"-Oberflächen: 15% Aufschlag

Optional packaging with wooden crate / Imballaggio opzionale con cassa in legno / Optionale Verpackung mit Holzkiste (260x90xH130) = € 900,00

Full-length drop-down door / Anta a ribalta a tutta lunghezza / Durchgehende Klapptür nach unten

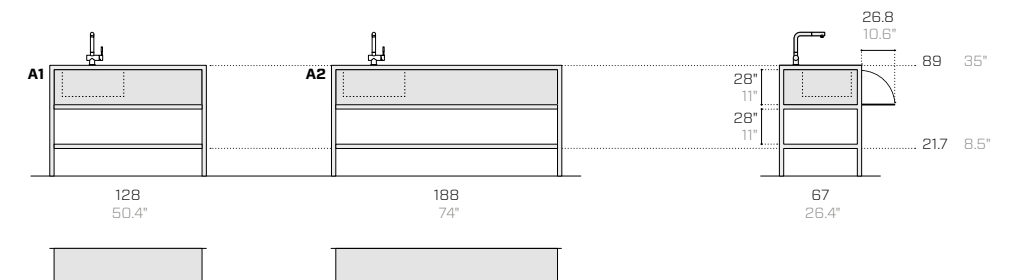

Stoneware or coated steel tops / Top in grès o acciaio verniciato / Arbeitsplatten aus Steinzeug oder lackierter Stahl

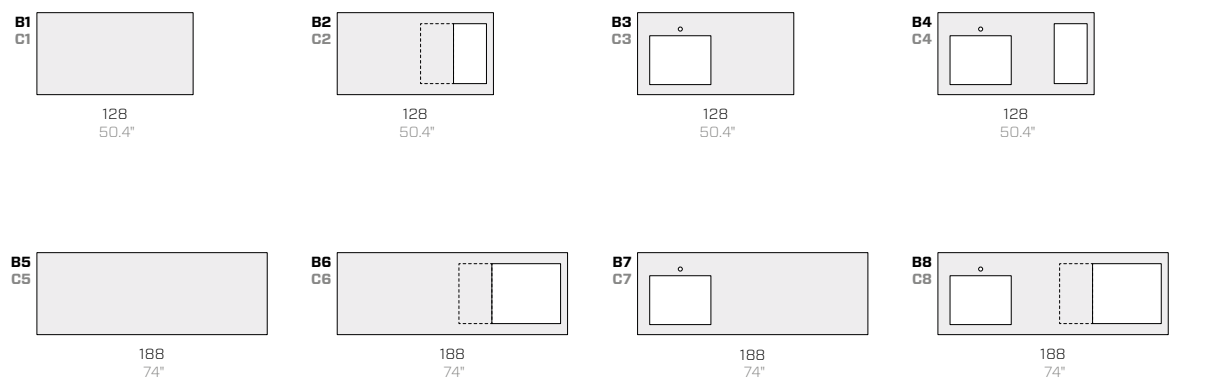

AISI 316 steel top, sink radius 12 mm / Top in acciaio AISI 316, vasca raggio 12 mm / AISI 316 Arbeitsplatte, Beckenradius 12 mm

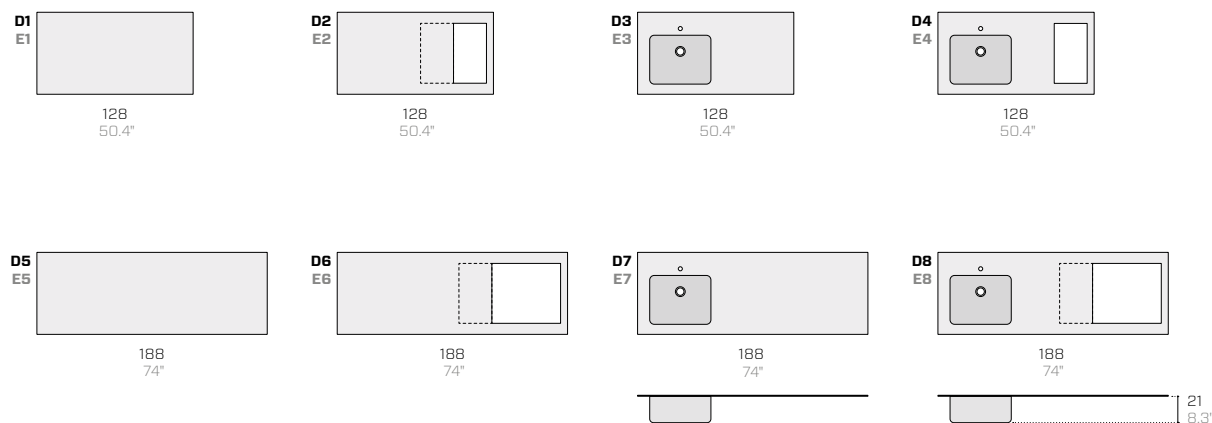

Indicative cut-outs for appliances: top customizable on request. For outdoor appliances, see QR code on page 226
 Forature per elettrodomestici indicative: top personalizzabile su richiesta. Per elettrodomestici outdoor, vedi QR code a pag. 226
 Indikative Ausschnitte für Geräte: Arbeitsplatte auf Anfrage anpassbar. Für Outdoor-Elektrogeräte siehe QR-Code auf S. 226

Product / Prodotto / Produkt

No. No. N°	Price Prezzo Preis	Code Codice Code	Dimensions (w-d-h)		Weight Peso Gewicht	Dimensions (w-d-h)		Weight Peso Gewicht	Vol pkg Vol. collo Vol. Kollo
			Dimensions (l-p-h)	Abmessungen (b-t-h)		Dimensions (l-p-h)	Abmessungen (b-t-h)		
	euro		cm	kg	cm	kg	mc		

Porcelain stoneware top 12 mm / Top in grès porcellanato 12 mm / Arbeitsplatte aus Feinsteinzeug 12 mm

B1	—	FR88TOPS-GC	128	67	1.2	27	137	80	21	37	0.3
B2	—	FR88TC-GC	128	67	1.2	25	137	80	21	35	0.3
B3	—	FR88TV-GC	128	67	1.2	22.5	137	80	21	32.5	0.3
B4	—	FR88TVC-GC	128	67	1.2	21	137	80	21	31	0.3
B5	—	FR81TOPS-GC	188	67	1.2	40	197	80	21	50	0.4
B6	—	FR81TC-GC	188	67	1.2	35.5	197	80	21	45.5	0.4
B7	—	FR81TV-GC	188	67	1.2	35	197	80	21	45	0.4
B8	—	FR81TVC-GC	188	67	1.2	31	197	80	21	41	0.4

Coated stainless steel top 3 mm / Top in acciaio inox verniciato 3 mm / Beschichtete Edelstahlplatte 3 mm

C1	—	FR88TOPS-316	128	67	0.3	18	137	80	21	26	0.3
C2	—	FR88TC-316	128	67	0.3	16	137	80	21	24	0.3
C3	—	FR88TV-316	128	67	0.3	13.5	137	80	21	21.5	0.3
C4	—	FR88TVC-316	128	67	0.3	12	137	80	21	20	0.3
C5	—	FR81TOPS-316	188	67	0.3	26	197	80	21	36	0.4
C6	—	FR81TC-316	188	67	0.3	21.5	197	80	21	31.5	0.4
C7	—	FR81TV-316	188	67	0.3	21	197	80	21	31	0.4
C8	—	FR81TVC-316	188	67	0.3	17	197	80	21	27	0.4

Satin steel top 6 mm, sink radius 12 mm / Top in acciaio satinato 6 mm, vasca raggio 12 mm / Satinierte Arbeitsplatte 6 mm, Beckenradius 12 mm

D1	—	FRX201S-316	128	67	0.6	21.6	137	80	21	31.6	0.3
D2	—	FRX202S-316	128	67	0.6	18.4	137	80	21	28.4	0.3
D3	—	FRX203S-316	128	67	0.6	20	137	80	50	34	0.6
D4	—	FRX204S-316	128	67	0.6	17.6	137	80	50	31.6	0.6
D5	—	FRX209S-316	188	67	0.6	32	197	80	21	42	0.4
D6	—	FRX210S-316	188	67	0.6	24.8	197	80	21	34.8	0.4
D7	—	FRX211S-316	188	67	0.6	30.4	197	80	50	44.4	0.8
D8	—	FRX212S-316	188	67	0.6	24	197	80	50	38	0.8

Vintage steel top 6 mm, sink radius 12 mm / Top in acciaio Vintage 6 mm, vasca raggio 12 mm / Vintage Arbeitsplatte 6 mm, Beckenradius 12 mm

E1	—	FRB41V-316	128	67	0.6	27	137	80	21	37	0.3
E2	—	FRB43V-316	128	67	0.6	23	137	80	21	33	0.3
E3	—	FRB45V-316	128	67	0.6	25	137	80	50	35	0.6
E4	—	FRB46V-316	128	67	0.6	22	137	80	50	32	0.6
E5	—	FRB71V-316	188	67	0.6	40	197	80	21	50	0.4
E6	—	FRB73V-316	188	67	0.6	31	197	80	21	41	0.4
E7	—	FRB75V-316	188	67	0.6	38	197	80	50	48	0.8
E8	—	FRB76V-316	188	67	0.6	30	197	80	50	40	0.8

Additional top 64x67 cm: 30% surcharge / Top aggiuntivo 64x67 cm: maggiorazione del 30% / Zusätzliche Oberfläche 64x67 cm: 30% Aufschlag

Single top max 376x134 cm: upon request / Top unico max 376x134 cm: su richiesta / Einteilige Arbeitsplatte max 376x134 cm: auf Anfrage

"Metal Design" finishes: 15% surcharge / Finiture "Metal Design": maggiorazione del 15% / "Metal Design"-Oberflächen: 15% Aufschlag

Optional packaging with wooden crate / Imballaggio opzionale con cassa in legno / Optionale Verpackung mit Holzkiste (260x90xH130) = € 900,00

Top thicknesses / Spessori dei top / Stärken der Arbeitsplatten

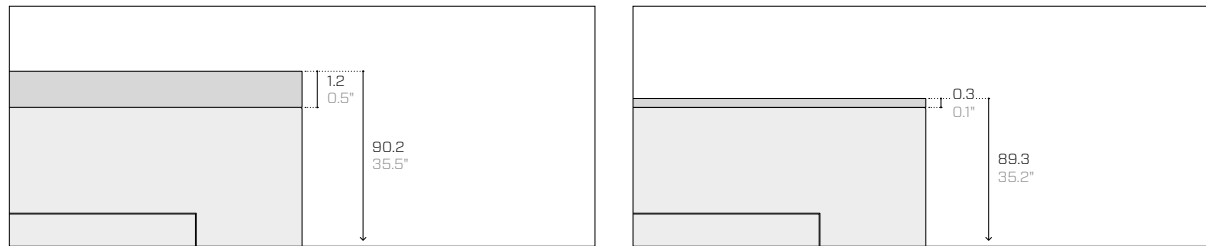

Porcelain stoneware top
Top in grès porcellanato
Arbeitsplatte aus Feinsteinzeug

Solid AISI 316 powder-coated SST top
Top in inox pieno AISI 316 verniciato a polveri
Pulverbeschichtete massive Edelstahl-Arbeitsplatte AISI 316

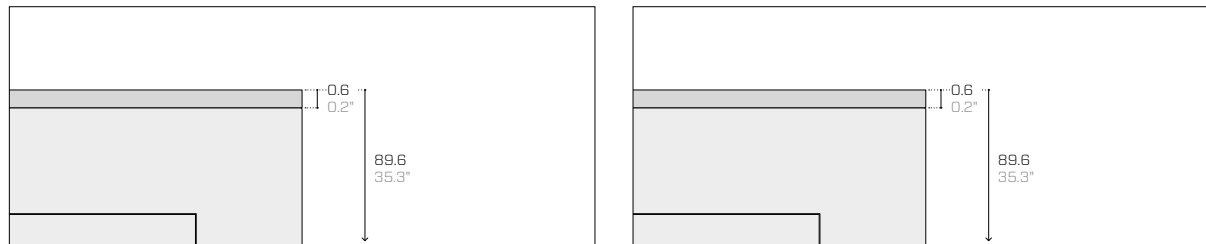

Boxed AISI 316 satin-finish SST top
Top in inox sciolato AISI 316 satinato
Satinirt gekastete Edelstahl-Arbeitsplatte AISI 316

Boxed AISI 316 Vintage-finish SST top
Top in inox sciolato AISI 316 Vintage
Vintage gekastete Edelstahl-Arbeitsplatte AISI 316

Other useful measurements / Altre quote utili / Andere nützliche Maße

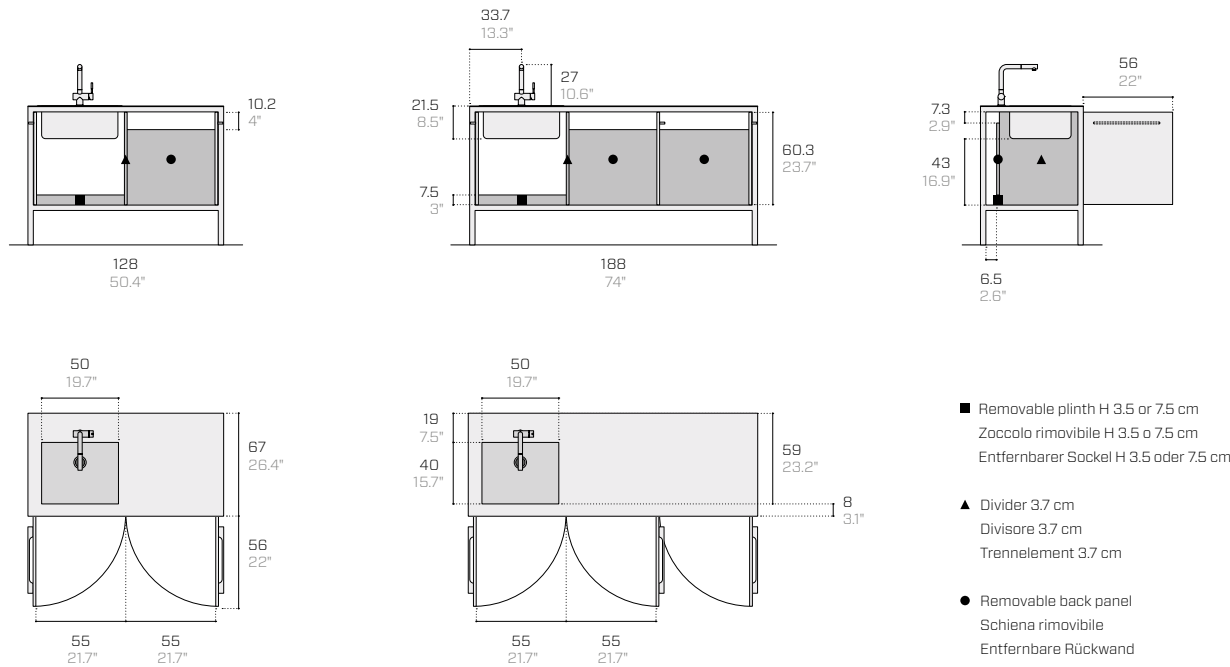

Accessories for tops and internal compartments / Accessori per top e vani interni / Zubehör für Arbeitsplatten und Innenfächer

Outdoor appliances and other accessories / Elettrodomestici outdoor e altri accessori / Haushaltsgeräte für Outdoor und anderes Zubehör



- Scan the QR code to get information on **appliances for outdoor** and **accessories**
- Scansiona il QR-Code per ottenere informazioni su **elettrodomestici per outdoor** e **accessori**
- Über den QR-Code erhalten Sie Informationen zu **Geräte für Outdoor** und **Zubehör**

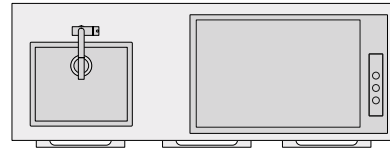

Backsplash matching top's finish / Alzatina in tinta con la finitura del top / Aufkantung in der gleichen Farbe wie die Arbeitsplatte

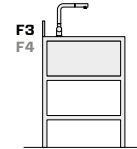
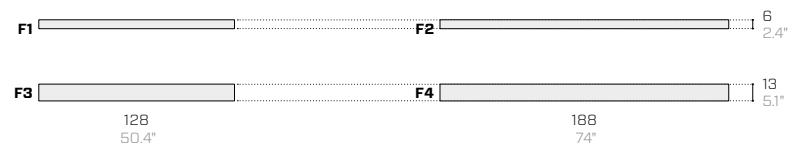

Other SST accessories for tops / Altri accessori in inox per top / Weitere Zubehör aus Edelstahl für Arbeitsplatten

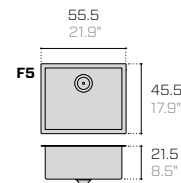

Satin overtop sink
 Vasca satinata sopratop
 Satiniertes Überbaubecken

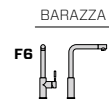

Tap without pull-out spray
 Rubinetto senza doccino estraibile
 Wasserhahn ohne ausziehbarer Brause

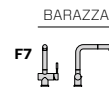

Tap with pull-out spray
 Rubinetto con doccino estraibile
 Wasserhahn mit ausziehbarer Brause



Telescopic tap
 Rubinetto abbattibile
 Teleskop-Wasserhahn

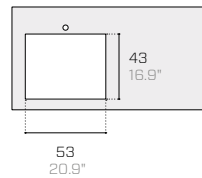

Hole size for the P1 sink
 Foratura top per vasca P1
 Größe der Bohrungen für Beck P1

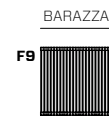

Roll-up draining mat
 Griglia multiuso avvolgibile
 Aufrollbare Abtropfmatte

Product / Prodotto / Produkt

Packaging / Imballo / Verpackung

No.	Price	Code	Dimensions (w-d-h)	Weight	Dimensions (w-d-h)	Weight	Vol pkg
No.	Prezzo	Codice	Dimensioni (l-p-h)	Peso	Dimensioni (l-p-h)	Peso	Vol. collo
N°	Preis	Code	Abmessungen (b-t-h)	Gewicht	Abmessungen (b-t-h)	Gewicht	Vol. Kollo
			cm	kg	cm	kg	mc
			euro				

Backsplash matching top's finish / Alzatina in tinta con la finitura del top / Aufkantung in der gleichen Farbe wie die Arbeitsplatte

F1	-	FR000	128 - 6	-	137 5 10	3	0.1
F2	-	FR000	188 - 6	-	197 5 10	3	0.1
F3	-	FR000	128 - 13	-	137 5 10	3	0.1
F4	-	FR000	188 - 13	-	197 5 10	3	0.1

Satin overtop sink / Vasca satinata sopratop / Satiniertes Überbaubecken

F5	-	FRB27S-316	55.5 45.5 21.5	6.5	59.5 49.5 27	8.5	0.1
----	---	------------	----------------	-----	--------------	-----	-----

Tap without pull-out spray / Rubinetto senza doccino estraibile / Wasserhahn ohne ausziehbarer Brause

F6	-	FRB26S	11 26 35	2.5	44 34 7	3.5	0.1
----	---	--------	----------	-----	---------	-----	-----

Tap with pull-out spray / Rubinetto con doccino estraibile / Wasserhahn mit ausziehbarer Brause

F7	-	FRB10S-316	13 26 27	5	59 25 10	8	0.1
----	---	------------	----------	---	----------	---	-----

Telescopic tap / Rubinetto abbattibile / Teleskop-Wasserhahn

F8	-	FRB27S	5.5 30.5 27.3	1	58 37 8	2	0.1
----	---	--------	---------------	---	---------	---	-----

Roll-up draining mat / Griglia multiuso avvolgibile / Aufrollbare Abtropfmatte

F9	-	FRB11	47 45 1	1	50 8 8	1	0.1
----	---	-------	---------	---	--------	---	-----

Waste separation systems / Kit di contenitori per raccolta differenziata / Abfalltrennsystem

Q1	-	FRK64DIE	47 52 25	3	53 50 30	4	0.1
----	---	----------	----------	---	----------	---	-----

Additional shelf / Ripiano aggiuntivo / Zusätzlicher Einlegeboden

Q2	-	FRK36R-316	56.5 46 2	2.5	60 50 6	2.6	0.1
Q3	-	FRK43R-316	116.5 46 2	5	120 50 6	6	0.1

"Metal Design" finishes: 15% surcharge / Finiture "Metal Design": maggiorazione del 15% / "Metal Design"-Oberflächen: 15% Aufschlag

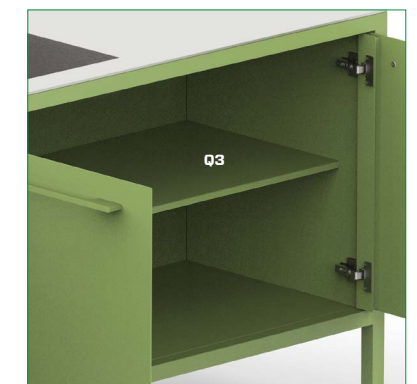
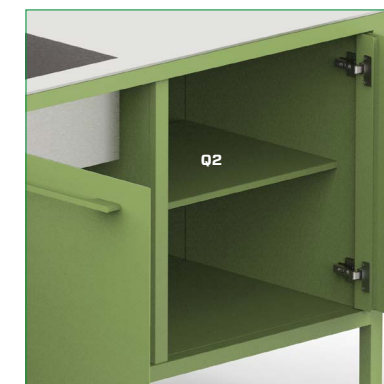
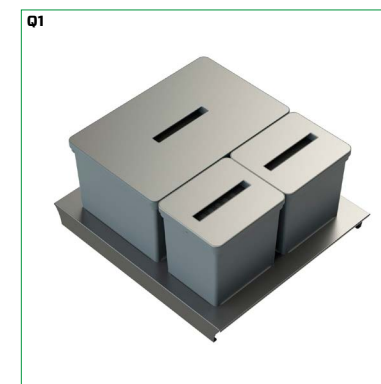

Accessories for freestanding kitchens / Accessori per cucine freestanding / Zubehör für freistehende Küchen

Backboards / Schiene / Rückwände

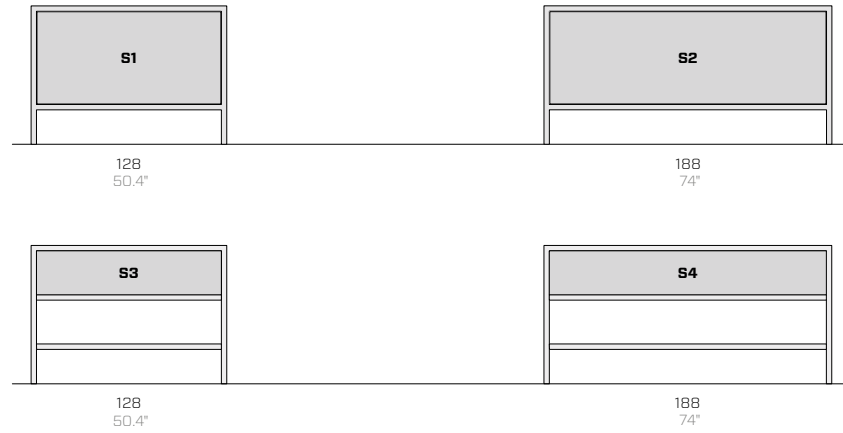

Attachment cover kit / Kit di copertura allacciamenti / Set für Abdeckung der Anschlüsse

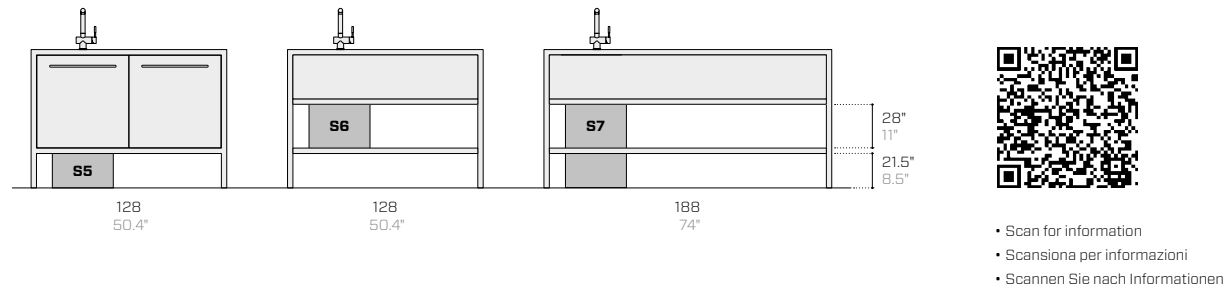

Wheel kit with colour-matching discs / Kit ruote con dischi in tinta / Radsatz mit farblich abgestimmten Scheiben

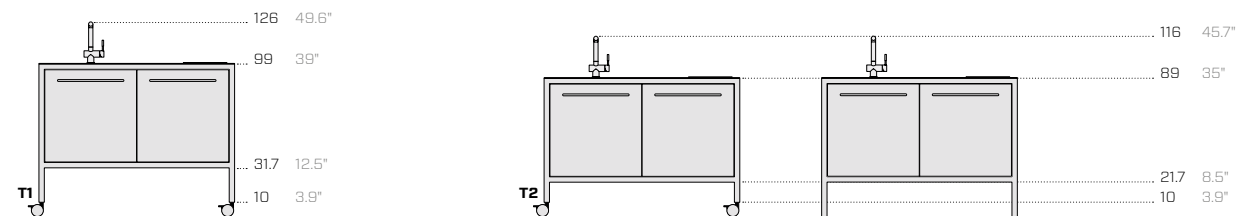

Kitchen height (with wheels)
Altezza cucina (con ruote)
Küchenhöhe (mit Rädern)

Kitchen with wheel kit and resized legs (same overall height as the kitchen without wheel kit)
Cucina con kit ruote e gambe ridimensionate (stessa altezza complessiva della cucina senza kit ruote)
Küche mit Radsatz und verkleinerte Beine (gleiche Gesamthöhe wie der Küche ohne Radsatz)

Product / Prodotto / Produkt

Packaging / Imballo / Verpackung

No.	Price	Code	Dimensions (w-d-h)	Weight	Dimensions (w-d-h)	Weight	Vol pkg
No.	Prezzo	Codice	Dimensioni (l-p-h)	Peso	Dimensioni (l-p-h)	Peso	Vol. collo
N°	Preis	Code	Abmessungen (b-t-h)	Gewicht	Abmessungen (b-t-h)	Gewicht	Vol. Kollo
			cm	kg	cm	kg	mc
			euro				

Backboards / Schiene / Rückwände

S1	-	FRK37S1-316	120 3 60	6	124 64 7	7	0.1
S2	-	FRK38S2-316	180 3 60	9	184 64 7	10	0.1
S3	-	FRK39S1-316	120 3 28	3	124 35 7	4	0.1
S4	-	FRK40S2-316	180 3 28	4.5	184 35 7	6	0.1

Floor attachment cover kit / Kit di copertura allacciamenti a pavimento / Set für Abdeckung der Anschlüsse am Boden

S5	-	FRK03A1-316	40 20 21.5	3	43 23 24.5	5	0.1
S6	-	FRK41A1-316	40 20 28	4	43 23 31	5	0.1
S7	-	FRK44A1-316	40 20 49.5	7	43 23 52.5	10	0.1

Wheel kit with colour-matching discs / Kit ruote con dischi in tinta / Radsatz mit farblich abgestimmten Scheiben

T1	-	FRK31R8	8 3.5 10	2	20 10 10	2.5	0.1
T2	-	FRK33R8	8 3.5 10	2	20 10 10	2.5	0.1

"Metal Design" finishes: 15% surcharge / Finiture "Metal Design": maggiorazione del 15% / "Metal Design"-Oberflächen: 15% Aufschlag

Top extension 23 cm: 30% surcharge / Allargamento top 23 cm: maggiorazione del 30% / Arbeitsplattenerweiterung 23 cm: 30% Aufschlag

Frame extension 23 cm: 15% surcharge / Allargamento telaio 23 cm: maggiorazione del 15% / Rahmenerweiterung 23 cm: 15% Aufschlag



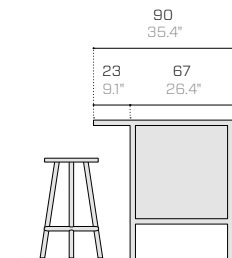









Top extension / Allargamento top / Arbeitsplattenerweiterung











Cantilever top extension for all configurations, with welded frame
Allargamento top a sbalzo per tutte le configurazioni, con telaio saldato
Arbeitsplattenerweiterung in Ausführung als Überstand für alle Konfigurationen, mit geschweißtem Rahmen



Metal Essentials

	02.18 Anthracite (RAL 7021) Antracite / Anthrazit --- EM ▲●		09.24 Terracotta (RAL 8004) Terracotta / Terrakotta --- EM ▲●		15.19 Forest green (RAL 6007) Verde bosco / Waldgrün --- EM ▲●
	03.18 Fantin grey Grigio Fantin / Fantin-Grau --- EM ▲●		11.21 Melon yellow (RAL 1028) Giallo melone / Melonengelb --- EM ▲●		16.24 Cement (RAL 7033) Cemento / Zement --- EM ▲●
	04.18 Light grey (RAL 7035) Grigio luce / Lichtgrau --- EM ▲●		13.21 Pastel green (RAL 6019) Verde pastello / Weißgrün --- EM ▲●		17.24 Slate (RAL 7031) Ardesia / Schiefer --- EM ▲●
	07.21 Milk white (RAL 9001) Bianco latte / Milchweiß --- EM ▲●		14.18 Sage green (RAL 6021) Verde salvia / Salbeigrün --- EM ▲●		19.18 Gentian blue (RAL 5010) Blu genziana / Enzianblau --- EM ▲●

Metal Design

	62.24 Copper Rame / Kupfer --- EM ▲●		51.18 Sand Sabbia / Sand --- EM ▲●
	63.24 Graphite Grafite / Graphit --- EM ▲●		57.21 Clay Creta / Lehm --- EM ▲●
	64.24 Silver green Verde argento / Silbergrün --- EM ▲●		52.18 Moss Muschio / Moos --- EM ▲●
	65.24 Silver blue Blu argento / Silberblau --- EM ▲●		67.24 Pink clay Argilla rosa / Rosa Ton --- EM ▲●

For “Metal Design” finishes (Metallic, Earth), a 15% surcharge is applied. For orders with products of the same model in more than three different colours, Fantin reserves the possibility to evaluate a handling fee, discreetly according to order. All Fantin outdoor products should be placed under a shelter, protected from atmospheric agents. It is advisable to clean the surfaces regularly according to the instructions for use and maintenance.

Per le finiture “Metal Design” (Metallic, Earth), è prevista una maggiorazione del 15%. Per ordini con prodotti dello stesso modello in più di tre colori, Fantin si riserva la possibilità di valutare un addebito per la gestione. I prodotti Fantin outdoor devono essere collocati sotto una copertura, al riparo dall'esposizione diretta agli agenti atmosferici. Si consiglia di pulire regolarmente le superfici, seguendo le prescrizioni di uso e manutenzione.

Für “Metal Design”-Oberflächen (Metallic, Earth) wird ein Aufschlag von 15% erhoben. Im Falle einer Bestellung mit Produkten desselben Modells in mehr als drei Farben, behält sich Fantin die Möglichkeit vor, einen Zuschlag für die Bearbeitung zu berechnen, mit Ermessensspielraum je nach Auftrag. Alle Outdoor Fantin-Produkte müssen vor Witterungseinflüssen unter einem Schutzdach aufzustellen. Es ist ratsam, die Oberflächen regelmäßig unter Beachtung der Gebrauchs- und Wartungsanweisungen zu reinigen.

Surfaces / Superfici / Oberflächen

EM Embossed / Goffrato / Gaufriert

Use / Utilizzo / Verwenden

- ▲ Tops / Top / Arbeitsplatte
- Outdoor / Esterni / Außenbereich
- Food / Alimentare / Lebensmittel

Stainless steel Acciaio inox Edelstahl CNS

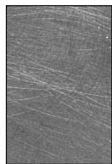

**K1.18
Inox Vintage**
Inox Vintage / Inox Vintage

HG ▲●■



**K2.19
Inox Satin**
Inox satinato / Inox satiniert

HG ▲●■

Porcelain stoneware Gres porcellanato Feinsteinzeug



**S1.26
Dark**
Scuro / Dunkel

EM ▲●■



**S2.26
Ash**
Cenero / Asche

EM ▲●■



**S3.26
Light**
Chiaro / Hell

EM ▲●■

Surfaces / Superfici / Oberflächen

EM Embossed / Goffrato / Gaufriert
HG High Gloss / Lucido / Glänzend

Use / Utilizzo / Verwenden

▲ Tops / Top / Arbeitsplatte
● Outdoor / Esterni / Außenbereich
■ Food / Alimentare / Lebensmittel

Technical information

All Fantin outdoor products must be kept under a shelter and protected from direct exposure to the elements. The surfaces should be cleaned and dried on a regular basis, in accordance with the use and maintenance instructions (see the warranty details in point 7 of the terms and conditions of sale).

Metal Non-toxic powder coating for interior use, with no heavy metals. Cured in an oven at 190°C, following degreasing and phosphating. Guaranteed minimum thickness of 50 microns. Minimum resistance to salt spray of 200 hours (in accordance with the ASTM B117 standard). Some finishes are suitable for direct contact with food as required by Italian Law Decree D.M. 21/03/73. Before the coating is added, it is possible to give the products a special treatment to make them more resistant to wear and exposure to the elements. Requests for other RAL finishes can be considered. On some finishes, any partial discolouration following rubbing and/or abrasion has absolutely no effect on the technical, appearance/colour and chemical/physical characteristics of the product. This phenomenon tends to diminish over the useful life of the product and does not in any case present a health hazard to users.

AISI 316 stainless steel Steel top with 6 mm (0.24") slim edge, made with an aluminium honeycomb support, available in Vintage (exclusive Barazza manual processing, making it quicker and easier to maintain) or satin finish. AISI 316 stainless steel – a material suitable for outdoor use – provides better resistance in environments where saltiness is present, particularly in seaside areas. It is also resistant to the corrosive effects of chlorine and particularly aggressive detergents.

Porcelain stoneware Full-body porcelain stoneware tops, thickness 12 mm (0.47"), highly resistant to impacts, scratches, chemicals and high temperatures, suitable for indoor and outdoor use.

Informazioni tecniche

I prodotti Fantin outdoor devono essere collocati sotto una copertura, al riparo dalla esposizione diretta agli agenti atmosferici. Si consiglia di pulire e asciugare regolarmente le superfici, seguendo le prescrizioni di uso e manutenzione (garanzia all'art. 7 nelle condizioni di vendita).

Metallo Verniciatura per interni a polveri atossiche prive di metalli pesanti, con saggio in forno a 190°C, previo trattamento di sgrassaggio e fosfatazione. Spessore minimo garantito 50 micron, resistenza minima in nebbia salina pari a 200 ore (norma ASTM B117). Alcune finiture sono idonee al contatto diretto con alimenti come previsto dal decreto italiano D.M. 21/03/73. Prima della verniciatura, è possibile l'applicazione di un trattamento al fine di rendere i prodotti più resistenti all'uso e all'esposizione agli agenti atmosferici. Altre finiture RAL sono valutabili su richiesta. Su alcune finiture, l'eventuale parziale cessione di colore in seguito a strofinamento e/o abrasione non influisce assolutamente sulle caratteristiche tecniche, di aspetto/colore, e chimico-fisiche del prodotto. Tale fenomeno tende a diminuire nel corso della vita utile del manufatto e non comporta in alcun caso pericoli per la salute degli utilizzatori.

Acciaio inox AISI 316 Piano in acciaio con Bordo Slim 6 mm (0.24"), realizzato con un supporto in alveolare di alluminio, disponibile in finitura Vintage (lavorazione manuale esclusiva Barazza, la cui manutenzione è più semplice e agevole) o satinata. L'acciaio inox AISI 316 – materiale idoneo per ambienti esterni – garantisce migliore resistenza in ambienti con presenza di salsedine, in modo particolare nelle zone di mare. È inoltre resistente agli effetti corrosivi del cloro e a detersivi particolarmente aggressivi.

Grès porcellanato Piani in grès porcellanato a tutta massa, spessore 12 mm (0.47"), ad elevata resistenza a urti, graffi, agenti chimici e alte temperature, idonei per utilizzo indoor e outdoor.

Technische Informationen

Alle Outdoor Fantin-Produkte müssen unter einem Dach aufgestellt werden, damit sie vor den direkten Einflüssen der Witterung geschützt sind. Die Oberflächen sollten regelmäßig unter Beachtung der Hinweise für Pflege und Wartung (Garantie unter Art. 7 der Geschäftsbedingungen) gereinigt und getrocknet werden.

Metal Die Pulverbeschichtung der gift- und schwermetalldfreien Pulverlacke für Innenbereiche erfolgt im Lackierofen bei 190°C nach vorheriger Entfettung und Phosphatierung. Die garantierte Mindeststärke der Lackschicht beträgt 50 Mikron bei einer Mindestprüfungsdauer von 200 Stunden im Salznebel (ASTM-Norm B117). Einige Oberflächen sind für den direkten Kontakt mit Lebensmitteln geeignet, wie in der Verordnung vorgesehen Italienisch D.M. 21/03/73. Vor der Pulverbeschichtung ist es möglich eine Behandlung auf die Oberfläche aufzutragen, um die Produkte für den Gebrauch und gegen Witterungseinflüsse widerstandsfähiger zu machen. Auf Anfrage können andere RAL-Finishes in Betracht gezogen werden. Bei einigen Ausführungen hat eine teilweise Verfärbung durch Reiben und/oder Abrieb keine Auswirkungen auf die technischen, optischen/farblichen und chemisch-physikalischen Eigenschaften des Produkts. Dieses Phänomen nimmt im Laufe der Nutzungsdauer des Produkts tendenziell ab und stellt in keinem Fall eine Gefahr für die Gesundheit der Benutzer dar.

Edelstahl CNS AISI 316 Stahlplatte mit 6 mm (0.24") Slim Edge, mit einem Aluminium Wabenträger gefertigt, in Vintage-Finish (exklusive Handverarbeitung Barazza, die leicht und bequem zu pflegen ist) oder satiniert erhältlich. Edelstahl AISI 316 – einem für den Außeneinsatz geeigneten Material – bietet eine bessere Beständigkeit in Umgebungen, in denen Salzigkeit vorhanden ist, insbesondere in Meeresgebieten. Er ist auch beständig gegen die korrosive Wirkung von Chlor und besonders aggressiven Reinigungsmitteln.

Feinsteinzeug Arbeitsplatten aus durchgefärbtem Feinsteinzeug, Stärke 12 mm (0.47"), hohe Beständigkeit gegen Stöße, Kratzer, Chemikalien und hohe Temperaturen, geeignet für Innen- und Außenbereiche.

Disclaimer / Esclusione di responsabilità / Haftungsausschluss

Fantin Srl reserves the right to change the dimensions and features of the products contained in this technical data sheet at any time and without prior notice. The finishes illustrated are purely indicative as the accuracy tolerances of printing processes should be taken into account.

Fantin Srl si riserva la facoltà di modificare in qualsiasi momento e senza preavviso le dimensioni e l'esecuzione dei prodotti contenuti nella presente scheda tecnica. Le finiture riportate hanno valore indicativo in quanto soggette alle tolleranze dei processi di stampa.

Fantin Srl behält sich das Recht vor, die angegebenen Maße und Ausführungen der Produkte, welche dieses Produktblatt enthält, jederzeit ohne Vorankündigung zu ändern. Aufgrund drucktechnischer Abweichungen dienen die dargestellten Ausführungen nur der Illustration.

Fantin Srl

via San Vito, 43
33080 - Bannia
di Fiume Veneto (PN)
Italia

t +39 0434 959 133
f +39 0434 560 037
fantin@fantin.com
www.fantin.com

