

- INSTRUCTION MANUAL -

LOOP STAND TABLE

L160 / 180 / 200 CM

L250 CM - Crossbar extension

Loop Stand Support

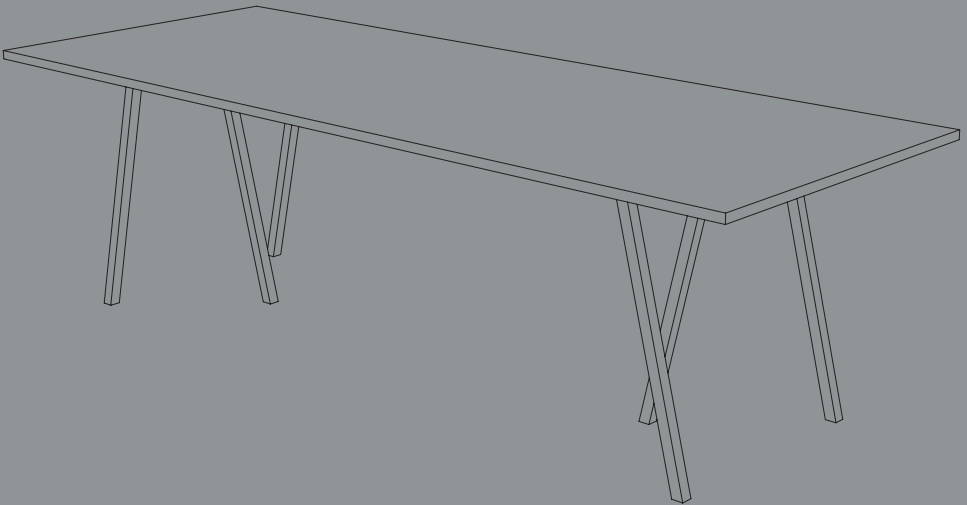

DESIGN BY LEIF JØRGENSEN

HAY

L160 / 180 / 200 CM



- PARTS -

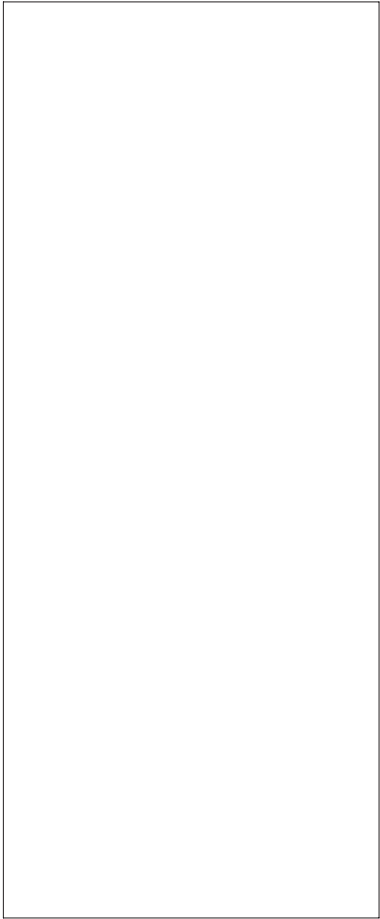

A Tabletop x1

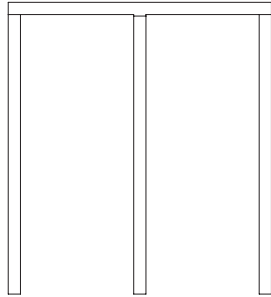

B Tristle x2



C Screw x4

- RECOMMENDED TRESTLE PLACEMENT -

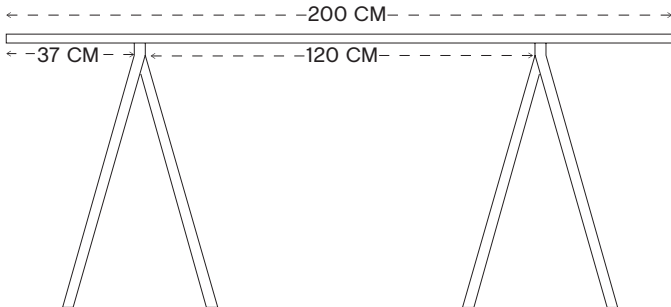
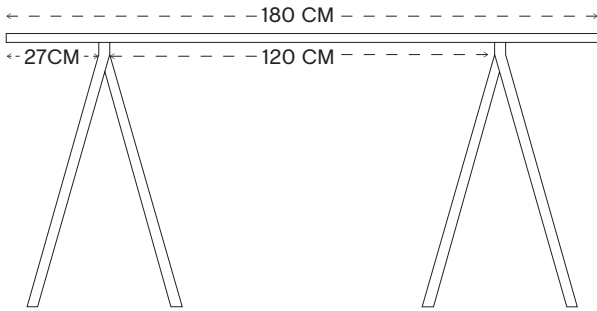
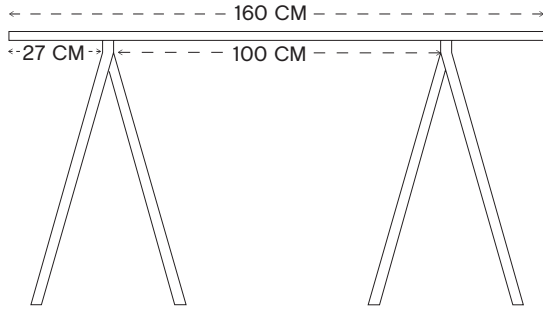

1.

Place the tabletop **A** on the trestles according to the recommended trestle placement. Insert the **C** parts, screwing them through the trestles and into the tabletop.

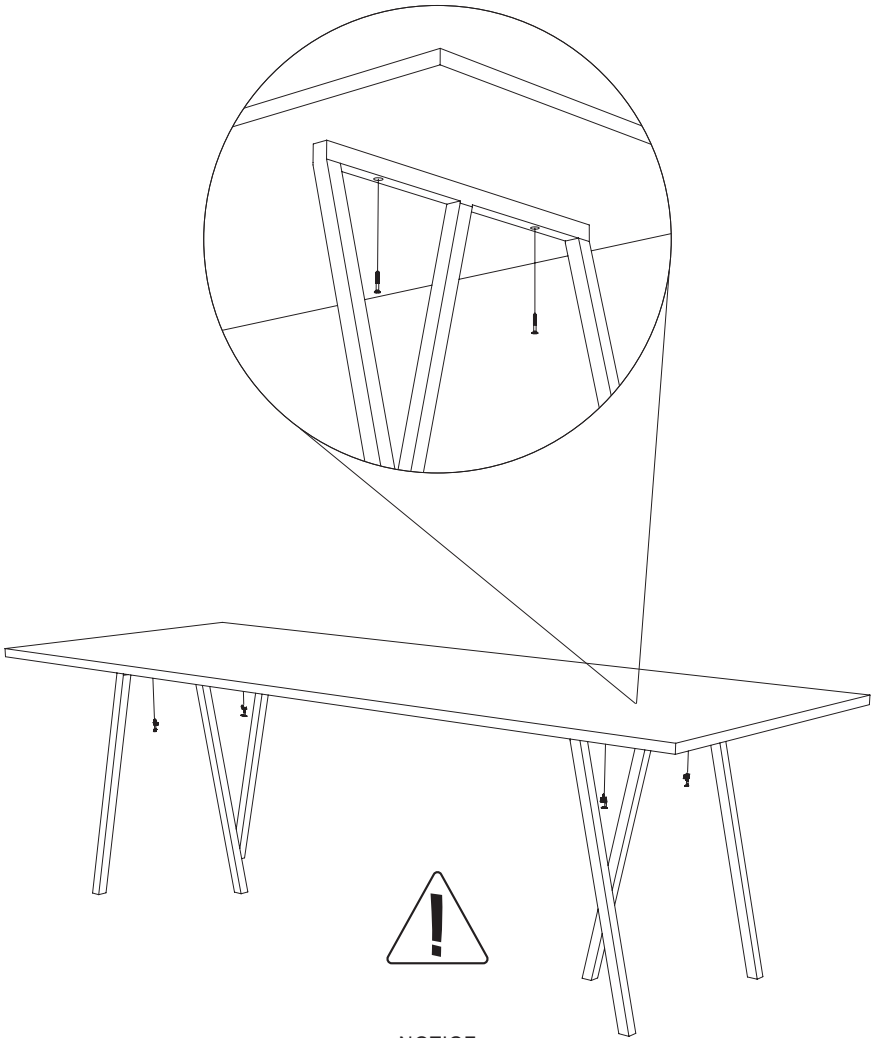

NOTICE

Make sure the table is upright
when mounting the base.

2.

Done!



L250 CM - Crossbar extension



- PARTS -



A Tabletop x1

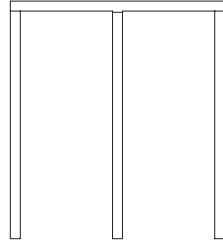

C Trestle x2



B Crossbar x2



D Screw x12

- RECOMMENDED TRESTLE PLACEMENT -

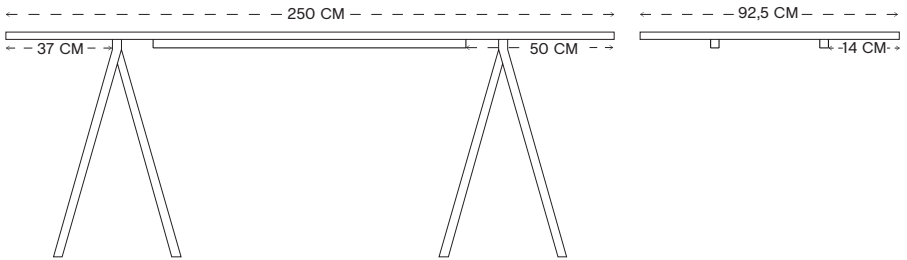

Protect the table top from scratches and other damage while assembling.

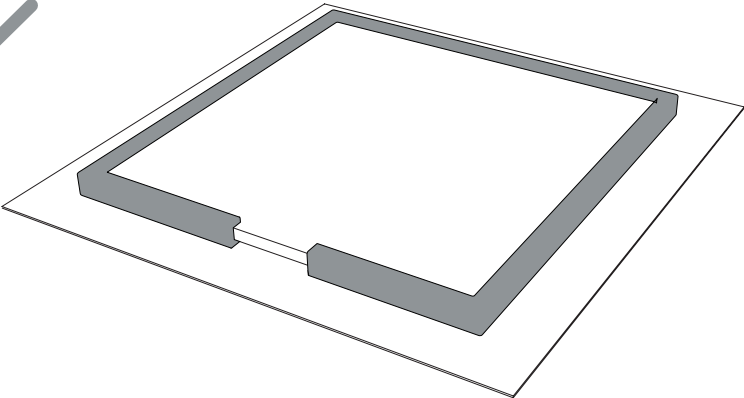
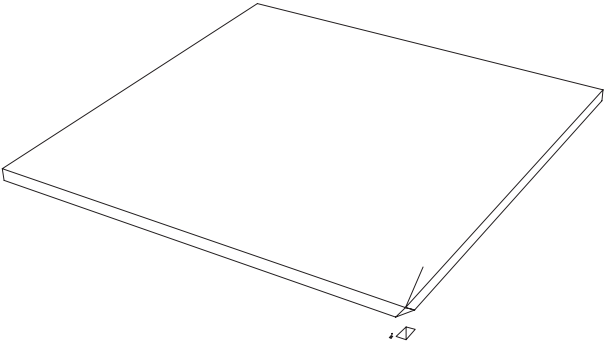

1.

Screw the **B** parts to the tabletop using the **D** parts.
Turn the tabletop over (2 persons recommended).

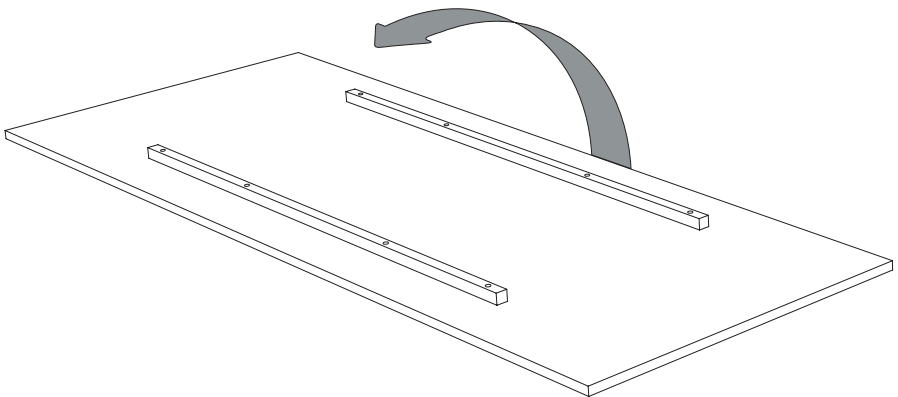
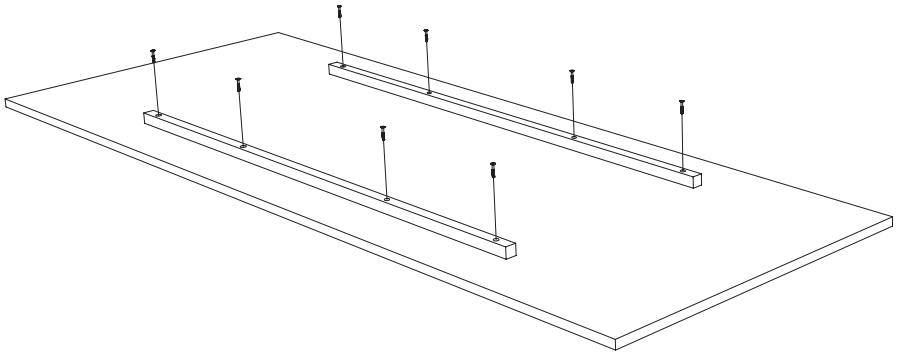

2.

Place the tabletop **A** on the trestles according to the recommended trestle placement. Insert the **D** parts, screwing them through the trestles and into the tabletop.

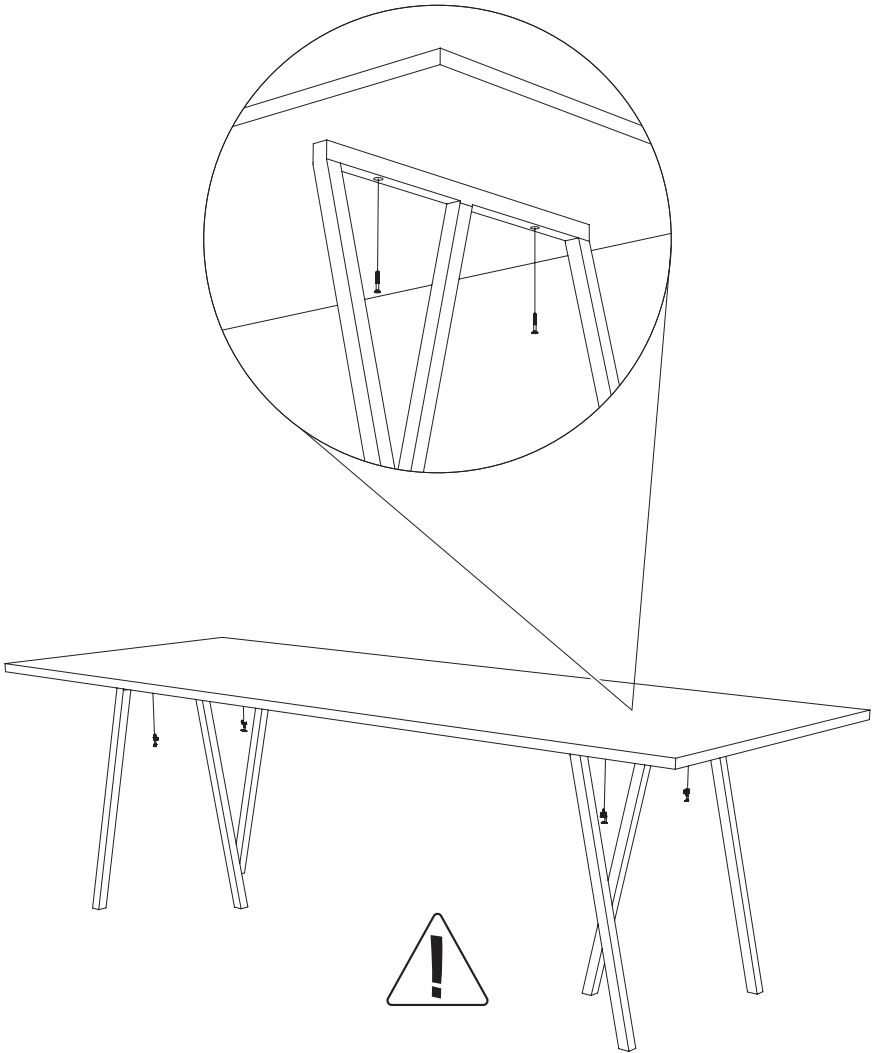

NOTICE

Make sure the table is upright
when mounting the base.

3.

Done!

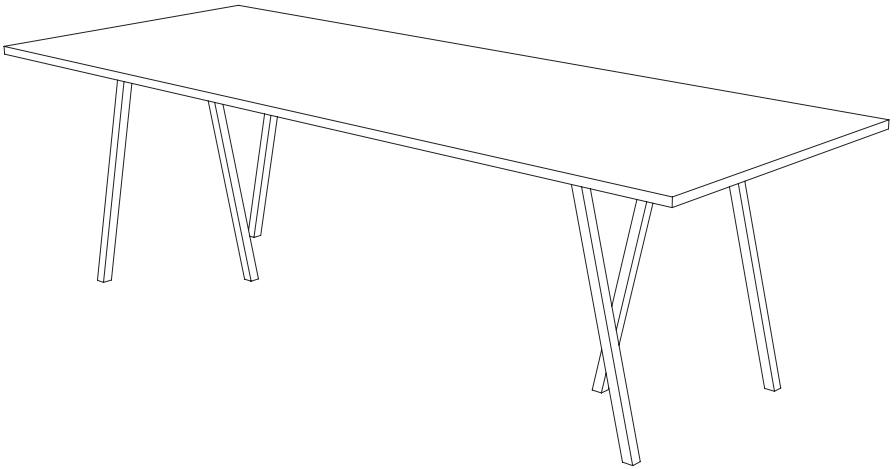

CAUTION

When you move your furniture, make sure you lift it rather than pulling or pushing it. If the table is unbalanced, please spread the trestle legs in order to align the legs.



NOTICE

Spread the trestles in order
to align the legs.

- LOOP STAND SUPPORT, OPTIONAL -

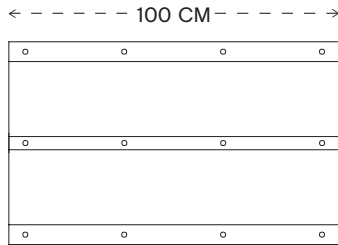

D Tabletop x1



E Screw x4



F Screw x12

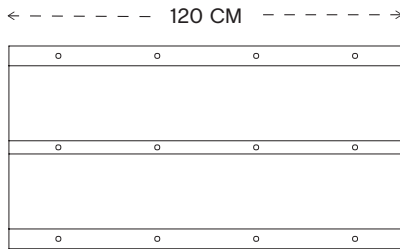

D Tabletop x1



E Screw x4



F Screw x12

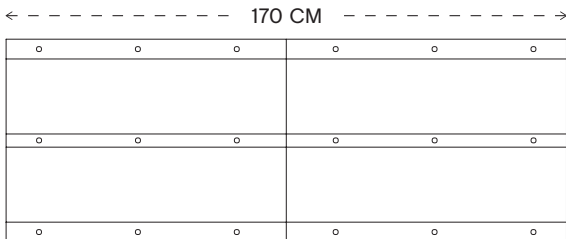

D Tabletop x1



E Screw x4



F Screw x18

1.

Place the trestles standing upright, and slide in the support **D** using the **E** parts.
Do not tighten the **E** parts completely in order to slide in the support **D**.

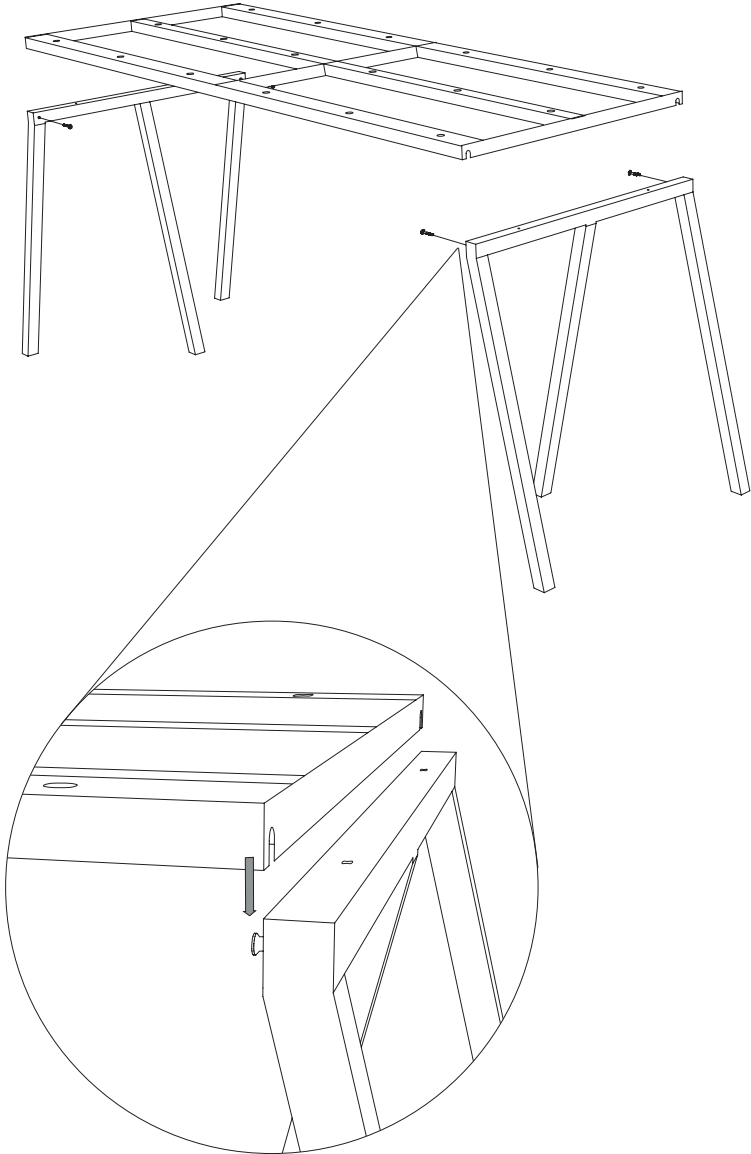

2.

Tighten the **E** part to secure the support **D** to the trestle.

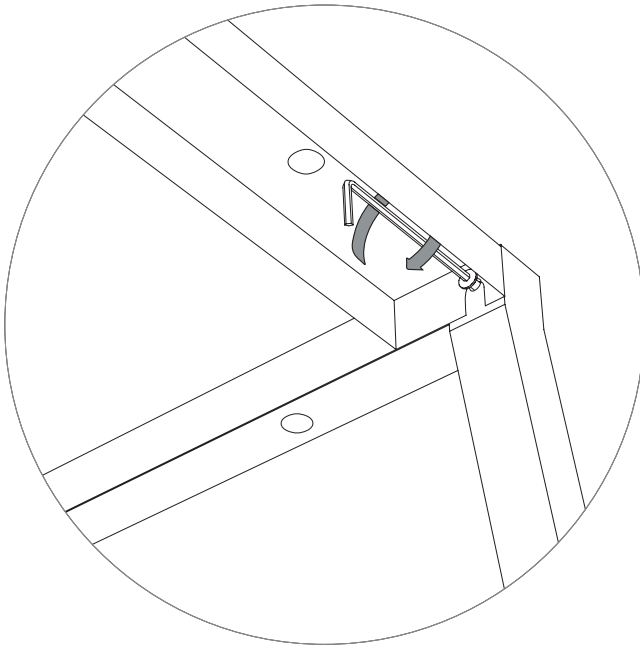

3.

Screw the support **D** into the tabletop **A** using the **F** parts.

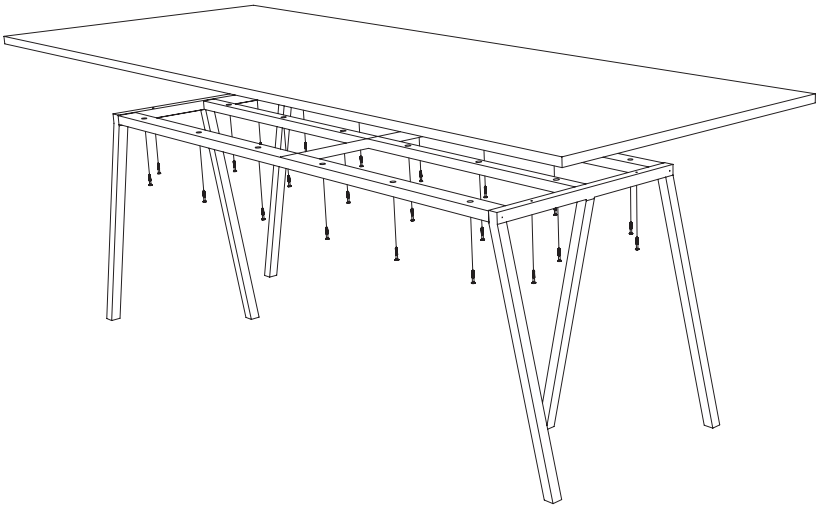

4.

Done!



- CARE & MAINTENANCE -

Our Care & Maintenance offers guidance for optimal maintenance of your HAY product. It includes advice and instructions on cleaning and caring for specific materials to prolong the life of your furniture.



Please find our Care & Maintenance guide by scanning the QR code



You can find more relevant information on Loop Stand Table by scanning the QR code

You can also find the same information here
hay.dk/downloads

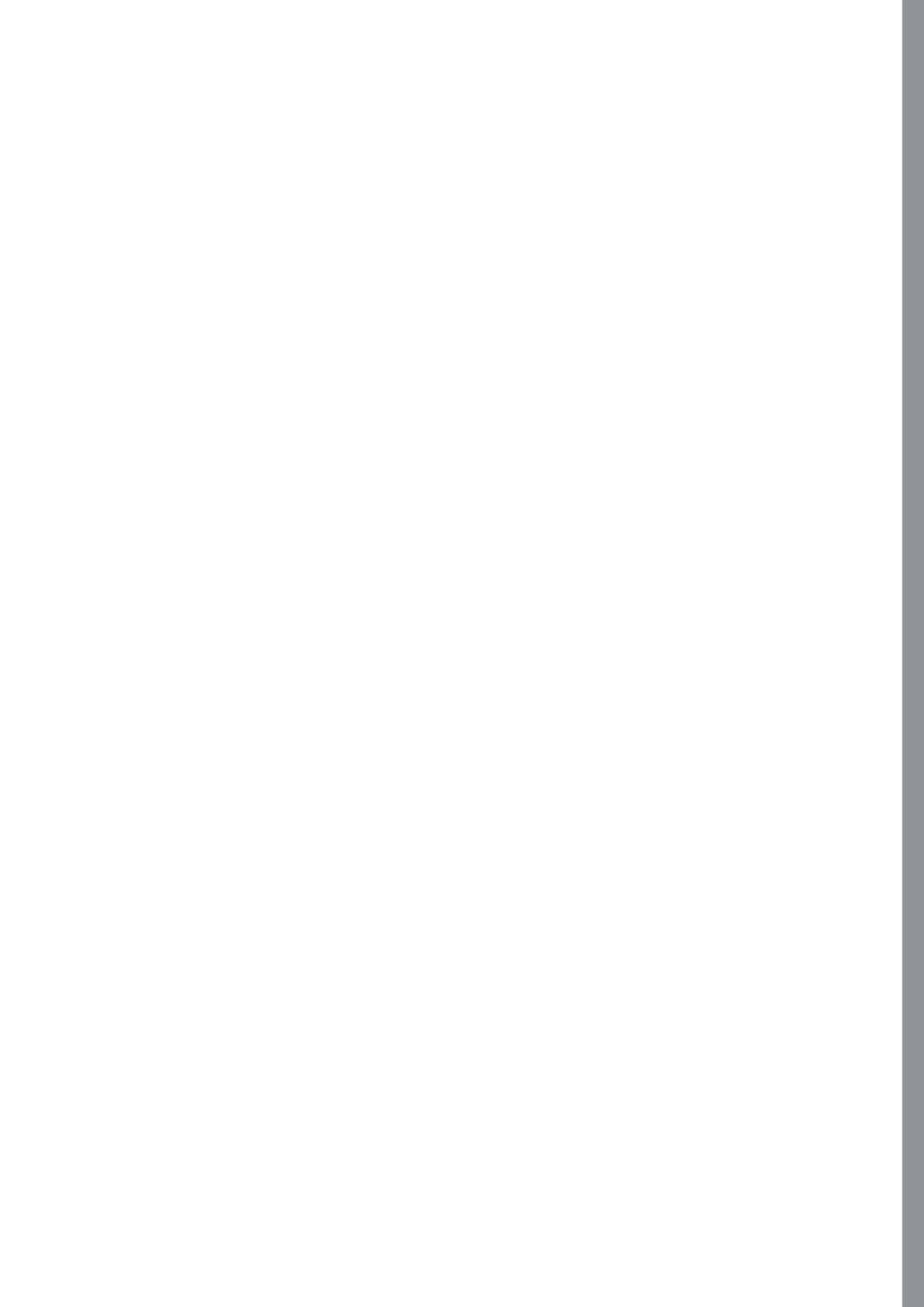

Havnen 1 8700 Horsens Denmark
+45 4282 0282 / hay@hay.com

10/03/2022

HAY