

- INSTRUCTION MANUAL -

# NEW ORDER

TROLLEY A & TROLLEY B

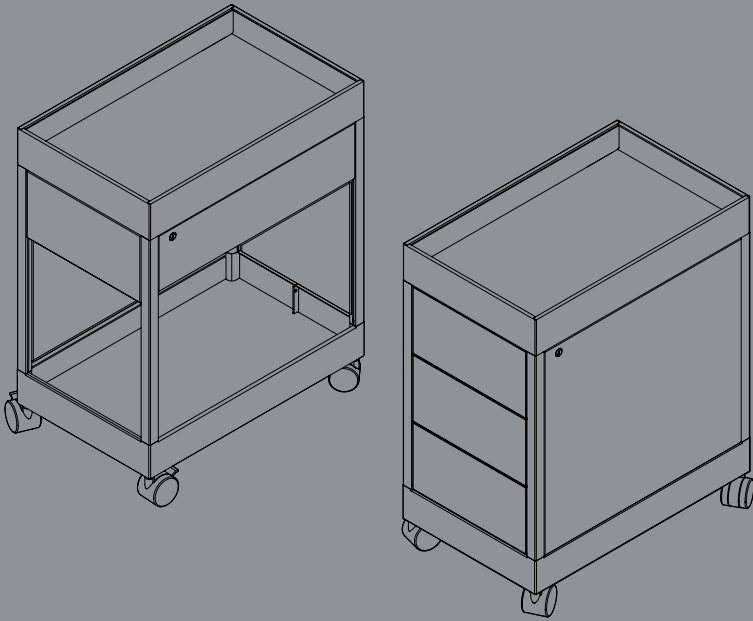

DESIGN BY STEFAN DIEZ

# HAY



1.

All drawers on the trolleys are opened with a “push to open” system. Make sure you always unlock the lock before trying to open the drawers. The front wheels can be locked in place, as shown in the illustration below.

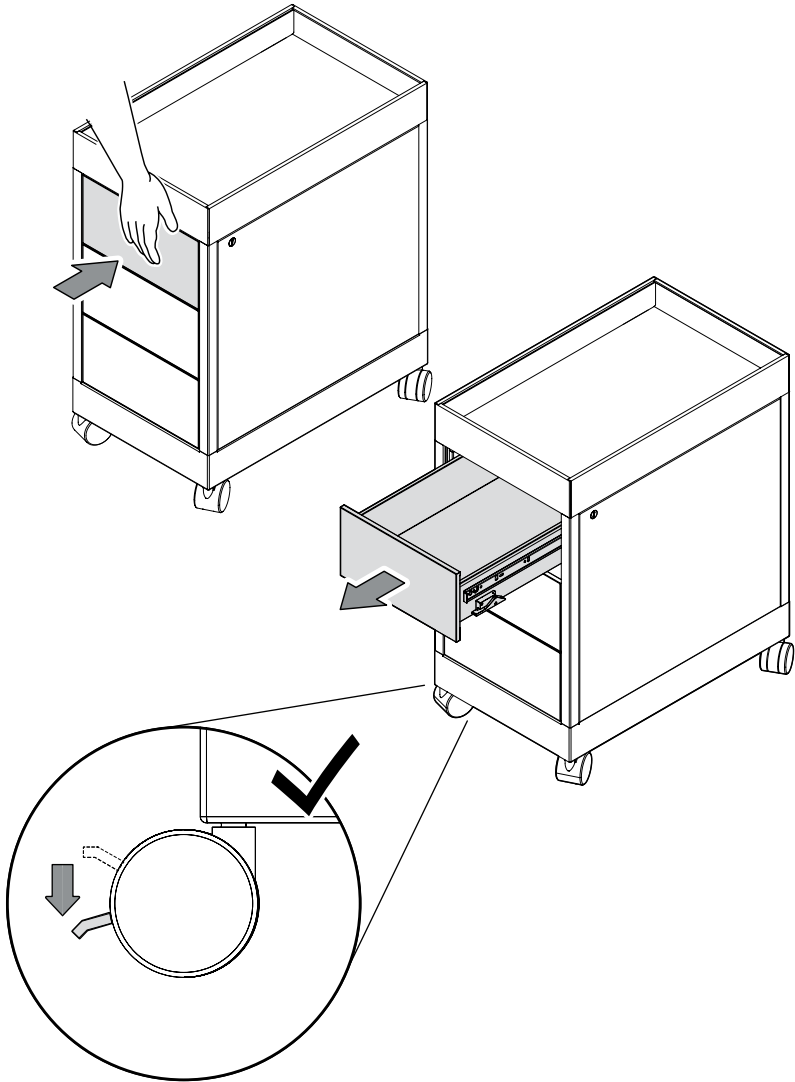

2.

Please note that the trolley has a lock to prevent tipping, which only allows you to open one drawer at a time.

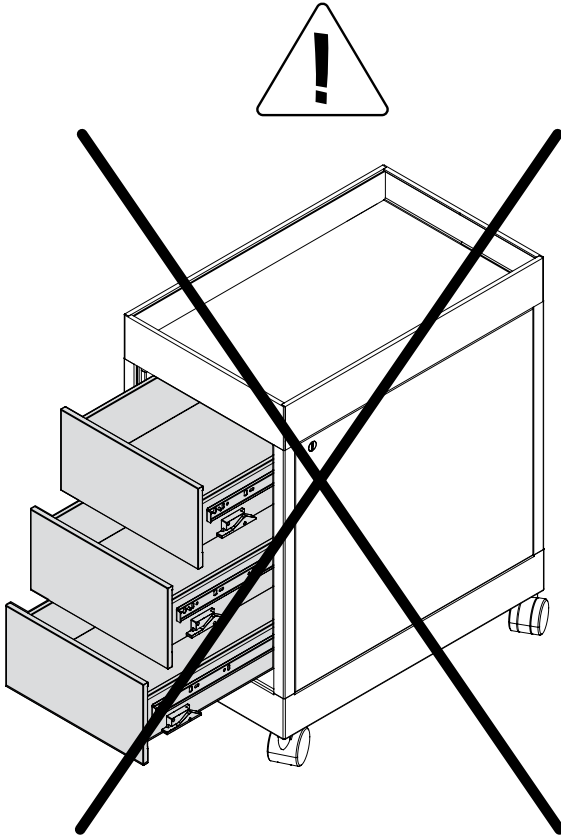

- CARE & MAINTENANCE -

Our Care & Maintenance offers guidance for optimal maintenance of your HAY product. It includes advice and instructions on cleaning and caring for specific materials to prolong the life of your furniture.



Please find our Care & Maintenance guide by scanning the QR code



You can find more relevant information on New Order Trolley by scanning the QR code

You can also find the same information here  
[hay.dk/downloads](http://hay.dk/downloads)





Havnen 1 8700 Horsens Denmark  
+45 3164 6000 / hay@hay.com

10/01/2023

**HAY**

ITEM NO. 850004



5 710441 289791