

Safety & Installation Instructions

These instructions are provided for your safety in order to prevent the risk of Fire, Electric shock or Injury. It is vitally important that they are read in their entirety before installing your fitting. Please retain for future reference.

1. If you are in any doubt consult a qualified electrician as to the installation of the fitting. Install in accordance with current IEE wiring regulations. It is recommended that this fitting is installed by a qualified electrician.
2. Ensure that the electrical supply is OFF. Disconnect the electrical supply at the fuse-board.
3. If removing an existing fitting first, note all wiring connections: record which of the house wires is connected to the live, neutral and earth terminals.
4. Carefully identify where the supply cable is (and check there are no other cables in the area) to avoid damage to concealed wiring during installation.
5. Position the light where desired ensuring that there is suitable support adjacent to where you will connect to the house supply and mark position of fixing holes, before drilling appropriate holes as below.
6.
 - a. Brick or masonry: Drill holes into which the wall plugs tightly fit, then insert wall plugs.
 - b. Wood: No hole necessary (unless small pilot hole required), screws can be screwed directly into the timber.
 - c. Plaster/Cavity: Special cavity wall fittings are required, rather than provided fixings. These are widely available from good hardware or DIY store and should come with their own instructions that must be followed. It may be easier to relocate the fitting so that you screw directly into a timber joist or beam.
7. Once desired drop determined, adjust the flex length accordingly. Consult an electrician if in any doubt.
 - Use wire cutters to cut flex at desired length and then remove 30mm of the cotton braid and outer insulation (making sure no damage occurs to the interior cables). Apply electrical tape around the end of the cotton braid to prevent fraying.
 - Remove 10mm of insulation from the conductors, ready to be wired into a connector block.
8. Support the fitting so that no strain is applied to the wiring when making the electrical connections. If necessary get a colleague to help.
9. Electrical connection: this light fitting must be earthed. Make connections using the connector block, following the diagram below. A small flat-head screwdriver is required.

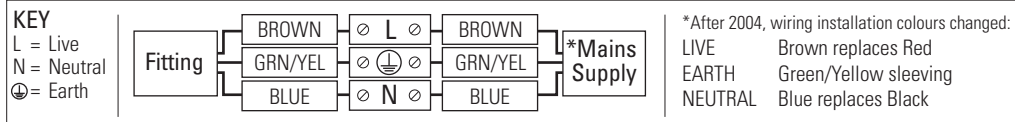

10. Double check all the connections are secure and that no loose strands of wire are left out of the connector, Use a good quality electrical insulation tape to cover the connector blocks and at least 25mm of the cables going in to either end of the connectors.
11. Check that no wires are trapped behind or within the fitting and complete the installation, see hanging instructions inside.
12. Fit the correct type and wattage of lamp (or less). Be careful not to overtighten the lamp.
13. Switch on at the fuse-board. Your light fitting is now ready for use.

Other Important Information

Switch off at mains before changing lamp(s). Never fit a lamp of greater wattage than recommended. Ensure children do not play with the light fitting. Dispose of old lamps carefully. Never leave a fitting without a lamp in position (or someone can accidentally touch the contacts). Adjust fitting only when power to the fitting is off and has been left to cool. If the electrical flex or electrical components become damaged at any point, power to the fitting should be disconnected immediately and not operated until the damaged parts are fixed/replaced. For use in a dry, indoor environment only. Ensure the fitting does not come into contact with any liquids.

Cleaning and Maintenance

Metal finishes should only be cleaned with a soft, dry cloth. Do not use polishes or abrasives. Glass may be cleaned using a suitable glass cleaner, avoid contact with metal finishes. Switch off power to the fitting before cleaning.

Established in 1990, Original BTC manufactures relaxed, familiar lighting for traditional and contemporary homes.

All products are hand-assembled in Oxford from high quality components, produced in the UK.

ORIGINALBTC.COM
+44 (0)1993 882 251
UNIT 21 / 22 AVENUE ONE, STATION LANE, WITNEY, OX28 4XZ, ENGLAND



Brompton Pendant Lights

Instruction Manual

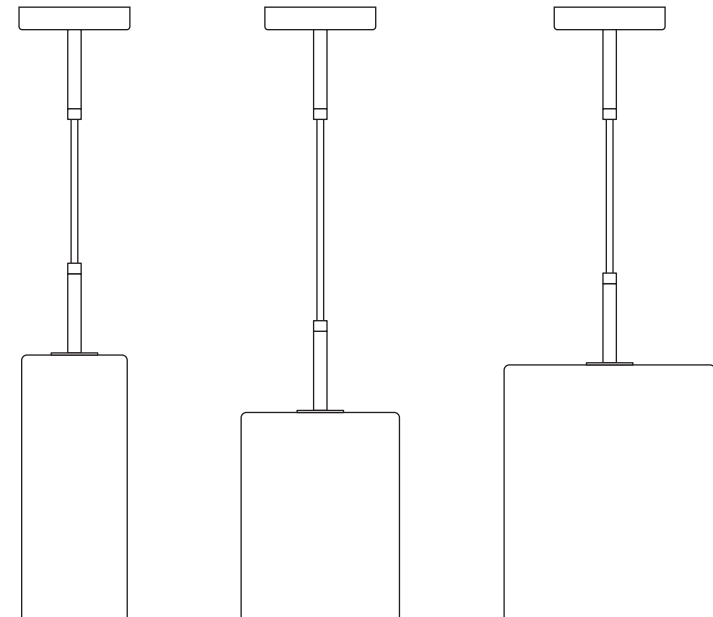

Size 1
FP610

Size 2
FP611

Size 3
FP612



ORIGINAL BTC
BRITISH LIGHTING MANUFACTURERS
LONDON - NEW YORK - PARIS



Brompton Pendant Lights

| 230V ac 50Hz | IP20

- FP610/AN/WE Brompton Pendant Size 1, Anthracite & Chrome
- FP611/AN/WE Brompton Pendant Size 2, Anthracite & Chrome
- FP612/AN/WE Brompton Pendant Size 3, Anthracite & Chrome

LAMP GUIDANCE			
BASE	SHAPE	TYPE*	WATTAGE**
		INCANDESCENT	60W MAX
E27	GLS		15W
		CFL	42W
		ECO-HALOGEN	10W
		LED	

* Warm white (2700k) low energy lamps recommended.
 ** Wattage value provided as a guide to suitable lamps. Lower wattage than stated may be used.

PLEASE READ THE INSTRUCTIONS ON THE REVERSE BEFORE YOU BEGIN INSTALLING YOUR LIGHT

Contents

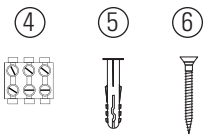
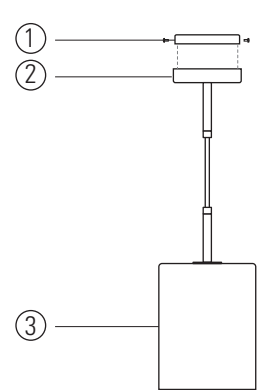

Contents

- 1 Fixing plate
- 2 Ceiling Plate cover
- 3 Glass Shade
- 4 Connector block
- 5 2 x Rawl Plugs
- 6 2 x Fixing screws

Tools Required

- Cross head screwdriver
- Small flat-head screwdriver
- Drill (if holes are required)

Installation Diagram

- A FIXING SCREWS
- B CONNECTOR BLOCK
- C MAINS SUPPLY
- D GALLERY SCREWS
- E FIXING BASE PLATE
- F FIXING PLATE COVER
- G CORD GRIP
- H LUMINAIRE CABLE
- I EARTH WIRE

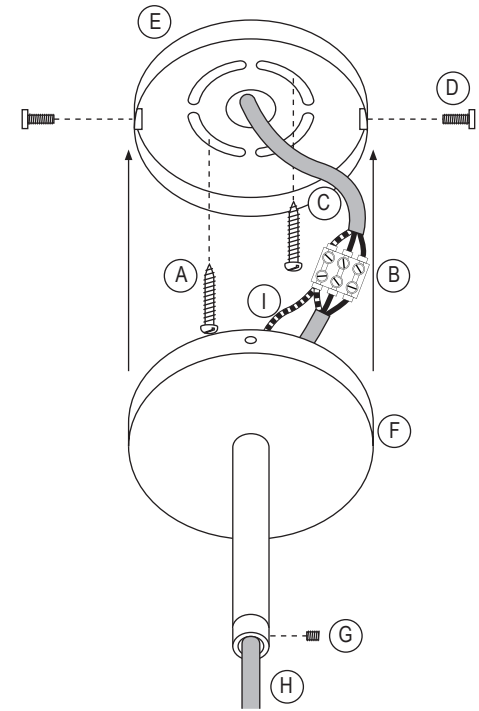

Hanging Instructions

This product is made from glass; take extra care when handling this product during installation.

Refer to instructions overleaf when installing your light.

- Screw the fixing base plate to the ceiling (ensure main supply cable has been inserted through the central hole first).
- Decide on the overall drop of the light, adjusting the cordgrip (G) and passing through required cable to shorten/lengthen the cable as required. When happy with the drop, secure the grub screw in the cord grip, ensuring it is firmly secured, but not overtightened so as to damage the cable, or the grub screw.
- With the luminaire cable inserted through the fixing plate cover, make connection to the mains as described overleaf.

With the fitting wired, the fixing plate cover can then be attached to the fixing base plate using the gallery screws (ensure pendant is supported at this point so as not to pull on connections).

Once lamp is inserted and power is restored, your fitting will be ready for operation.